

mjm [®] **35**



“Believe me, my young friend, said the water rat solemnly, there is nothing, absolutely nothing, half so much worth doing as simply messing about in boats. Simply messing...nothing seems really to matter. That's the charm of it. Whether you get away, or whether you don't, whether you arrive at your destination or whether you reach somewhere else, or whether you never get anywhere at all, you're always busy, and you never do anything in particular...”

...*The Wind in the Willows* by Kenneth Grahame



Dear 35 Owner,

Congratulations on becoming an owner of an MJM 35. We are dedicated to making it the world's best in class. As you read this guide and share cruising adventures, we hope you will discover our mission has been accomplished.

MJM's are built of the highest quality materials; strong, light, modified epoxy, infusion cored composite. That contributes to MJMs being most fuel-efficient yachts of their type by a wide margin. The same is true in the selecting of equipment suppliers and cabinetmakers. 35 is built to structural scantlings of Certified ISO Category B Offshore, the highest rating for seaworthiness achieved by a boat under 40 feet. 35 leads the outboard market with unusually complete standard specifications and amenities. The boats are safe, reliable, easy to handle by one person, and high performers. Last but not least, and our number one design mandate, they turn heads everywhere they go.

In addition to this Owner's Guide, and primary in terms of authority, is a portable file box with equipment, supplier and owner manuals and warranties. These documents contain an enormous amount of important information. Please keep them accessible for reference when you have an issue or question not covered in sufficient detail by this guide. You can download most from supplier websites or install them on your display.

This guide reflects our experience from building over 300 MJM's. I personally have spent more than 6000 hours cruising on MJM yachts so want to impart some advice and background information along with the "how to do it." See comments in the blue sidebars. As you enjoy your new boat, remember that much of the equipment contains computer chips that can sometime have glitches, which are often corrected with a re-boot.

With proper safety precautions and good weather planning, you will spend many enjoyable hours on your new vessel!

Peter L. Johnstone

Chairman

(252) 599-0223

peterj@mjmyachts.com



Boat Information



MODEL

HIN NUMBER

DESIGN PATENT US D475 338S (3 June 2003)

DELIVERY DATE _____

AIS MMSI NO. _____

REGISTRATION NO. _____

ENGINES

MODEL _____

SERIAL NUMBERS _____

PROPELLORS _____

MJM YACHTS LLC

Peter L. Johnstone

Phone

(252) 599-0223

Email

info@mjmyachts.com

MJM SERVICE CONTACT

Email

Warranty1@pamlicoyachtworks.com or jessicas@pamlicoyachtworks.com

DEALER _____

BROKER _____

PHONE _____

EMAIL _____

QUICK START GUIDE

Here's a reminder checklist for an experienced captain, familiar with operation of twin Mercury Verado outboards equipped with Joystick Piloting and information in this guide and accompanying binders.

- Check raw water systems** that raw water strainers of the GENERATOR and combined SEAKEEPER/ AIR CONDITIONING, located under aft cockpit seat are not clogged.

Change AC Power Source - Shore Power to Inverter or Generator

- For the inverter, nothing is required. The Victron Quattro combination charger/inverter has an automatic transfer switch and will instantly switch over. To operate the generator, Turn on the Generator Start switch at the top of the DC panel. Wait at least 30 seconds for the engine room blowers to operate. Then press the start button on the generator controller. After the generator starts, switch off the pedestal shore power breaker or on-board ELCI and unplug the shore power cable. The power will automatically transfer over to the generator.

Activate 12 Volt Equipment

- With both house battery switches on, turn on the 150A "DC MAIN" breaker at the top of the panel
- Turn on both the port and starboard battery switches above the DC MAIN breaker
- Insert and turn ON ENGINE KEYS high up under companionway bulkhead. Listen for acknowledging beep and look for Green "Systems OK" light on Vesselview.

CAUTION If start batteries are low, don't leave the dock until you diagnose and correct the problem.

- LOWER engines using rocker switch on port control handle, confirmed by trim bars in lower center on VesselView.

CAUTION Ensure people, equipment, lines and hoses are clear and not in the water before starting. **Start Your Engines**

- Momentarily TOUCH engine start buttons to starboard of wheel. Don't hold them in. It's automatic.
- TAP JOYSTICK lightly in any direction to insure it is functioning. The rim lights up GREEN.

Cast Off **CAUTION** Confirm that no one is on the foredeck or in the water.

- If everything is in order, cast off dock lines. When maneuvering with the JOYSTICK, minimize going back to center to avoid shifting of outboard gears. If moving sideways to clear a float: You can move the bow to catch up with the stern by twisting the knob at the same time while held sideways...likewise with moving the boat slightly forward or aft by leaning the joystick forward or aft while still leaning the joystick in the sideways direction desired.
- Move the SHIFT LEVER forward out of neutral normal operation to automatically disengage the JOYSTICK. The JOYSTICK is automatically ready for use (Green Lighted Rim) when SHIFT is in neutral.

CE CERTIFICATION

CERTIFICATE NO.

BBBW005

AUTHORITY: ADDRESS:

International Marine Certification Institute

Rue Abbe Cuypers 3

B-1040 Bruxelles. Belgique

PHONE

+32-2-741-2418

WEBSITE

www.imci.org

CLASSIFICATION

ISO CE Mark Design Category B Offshore (EC Directive 94/25/EC) for craft designed for offshore voyages (1) where the vessel is correctly handled in the sense of good seamanship and operated at a speed appropriate to the prevailing sea state and (2) with significant wave heights above 4 m (calculations are based on 7 m) and wind speeds in excess of Beaufort Force 8, but excluding abnormal conditions, e.g. hurricanes.

CAPACITY

Maximum 15 Persons

PERSONS

Maximum Load 3518 kg

PERSONS/GEAR

Maximum Load 3518 kg

RECEIPT BY OWNER In compliance with ISO 10240:1995(E) the owner hereby certifies receipt of this manual and has read and agrees to the terms of the Builder's Limited Warranty included herein.

NAME

Signature

Printed Name(s) and Date

BOAT

Boat Name and Hull Number

CONTACT INFORMATION

Street Address

City, State, Zip

Mobile Phone

e-Mail

Please sign one of the two copies of this page and return it in the attached stamped envelope to MJM Yachts, LLC, 230 Clarks Neck Road, Washington NC 27889

TABLE OF CONTENTS

1 INTRODUCTION	1	5.11 Bonding.....	21
1.1 Purpose and Limitations	1	6 WATER SYSTEMS	22
1.2 Standard Specifications	1	6.1 Fresh Water.....	22
1.3 Conventions	1	6.2 Hot Water.....	22
2 SAFETY and some USCG REQUIREMENTS	2	6.3 Gray Water.....	23
2.1 Binder Manuals.....	2	6.4 Raw Water.....	24
2.2 Standard Equipment.....	2	7 SEAKEEPER GYROSTABILIZER (Option)	25
2.3 Commissioning Package Safety Items.....	3	7.1 To Start the Gyro.....	25
2.4 USCG required equipment	3	7.2 Activate/De-activate	25
2.5 Additional Safety Equipment.....	3	8 EQUIPMENT, APPLIANCES and FINISHES	26
2.6 Some Additional USCG Requirements	3	8.1 Anchor Windlass.....	26
2.7 Fuel Shut-off Valves	4	8.2 Anchor Washdown	26
2.8 Fire Suppression	4	8.3 Fusion Multi-media Player	26
2.9 Notices	4	8.4 Privacy/Sunscreen Curtains (Option).....	27
2.10 Emergency and Thru Hull Diagram.....	5	8.5 Cooktop.....	28
3 PROPULSION	6	8.6 Microwave.....	28
3.1 Engines.....	6	8.7 Refrigerator.....	28
3.2 Engine Checks.....	6	8.8 Ice maker	28
3.3 5 Steps to Start	7	8.9 TV (optional).....	28
3.4 Stopping the Engines	7	8.10 Vacuum Flush Head System	29
3.5 New Engine Break-in	8	8.11 Air Conditioning (Optional)	29
3.6 Operating Parameters.....	8	8.12 Finishes.....	30
3.7 Leaving the Boat.....	8	9 APPENDIX	31
3.8 Mercury Verado 300 & 350 HP Engines.....	9	9.1 The Top 10 Causes of Engine Failure....	31
4 INSTRUMENTS AND CONTROLS	10	9.2 Diesel Operation.....	32
4.1 Helm Station	10	9.3 Starting with Low Batteries	34
4.2 Mercury Features and Controls (pages 56 - 77) 11		9.4 Winter Storage.....	35
4.3 Joystick Piloting	11	9.5 Spring Commissioning.....	36
4.4 DISPLAYS.....	12	9.6 Hauling Out and Blocking	36
4.5 Compass Heading and Calibration.....	12	9.7 Trailer Loading Checklist.....	36
4.6 Trimming the 35	12	9.8 Fuel Consumption	37
4.6.1 Engine Trim.....	12	9.9 Routine Maintenance.....	38
4.6.2 Mercury Active Trim.....	12	9.10 Boat Lift and Bunk Offsets.....	39
4.6.3 ZipWake Auto Trim.....	12	9.11 Systems Location Plan.....	40
4.7 Light Bar	13	9.12 Systems Key	41
4.8 MultiFunction Display (MFD)	13	9.13 Wiring Diagrams	42
4.9 Console Switch Panel.....	13	9.14 Fuse Locations & Specifications.....	43
4.10 Windshield Operation.....	14	9.15 Fuel Consumption Log	44
5 ELECTRICAL SYSTEMS	15	9.16 Pamlico Yachtworks Limited Warranty.....	45
5.1 Electrical Safety	15		
5.2 Electrical Power.....	15		
5.3 Shore Power.....	16		
5.4 Fuse Locations	16		
5.5 24-Hour Circuits	16		
5.6 The 12V DC Panel	17		
5.7 The 120V AC Panel	18		
5.8 Westerbeke 3.5 SBCG Generator (Option)19			
5.9 Generator Component Locations	20		
5.10 Victron Inverter/Charger	21		

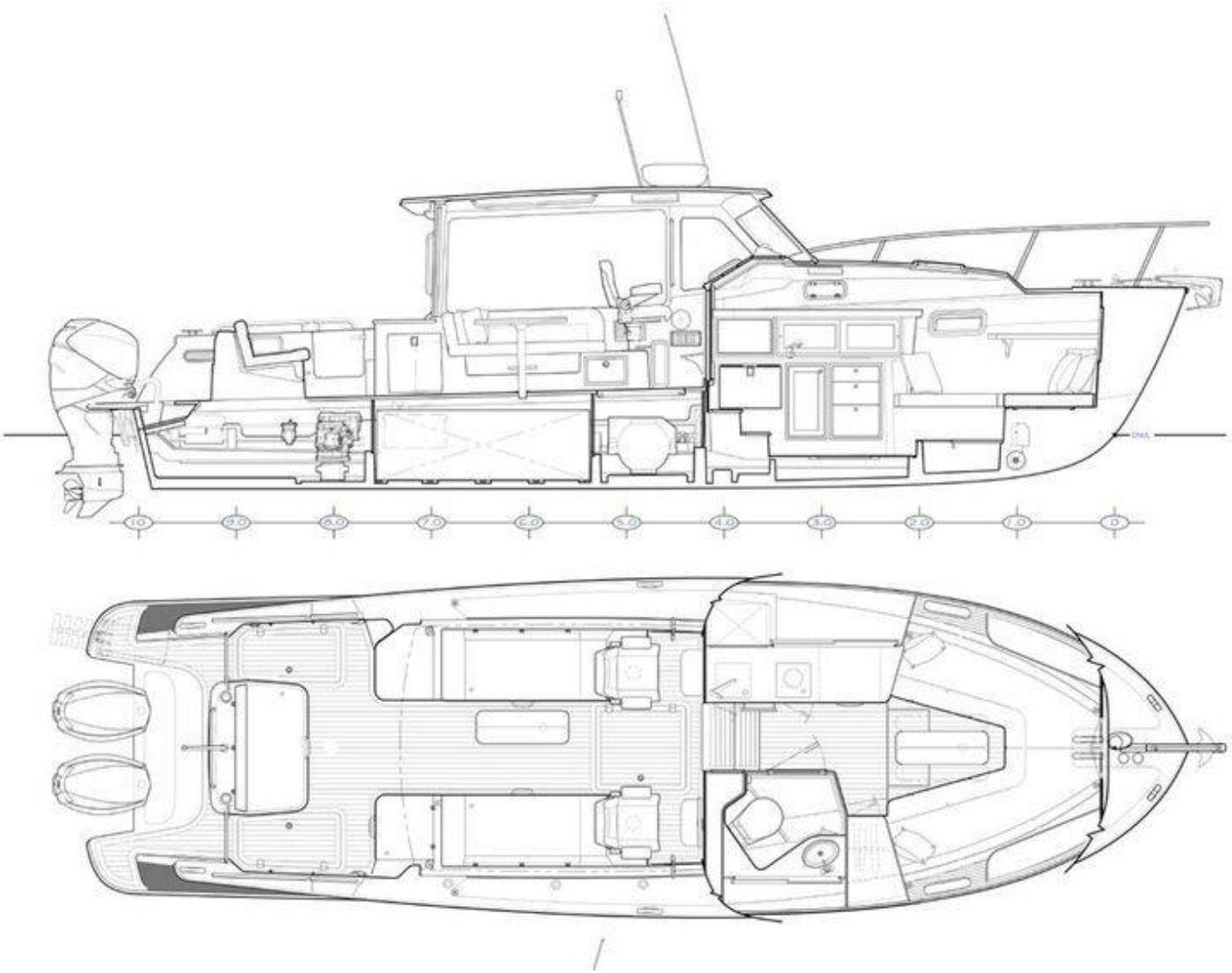

MJM 35

LOA: Length Over-All including engines down & bow roller.....	37' 11"
LOD: Length on deck (LOD).....	35' 8"
Beam (Maximum width on trailer).....	11' 0"
Maximum Trailer weight (full tanks).....	15,000 lbs
Draft with Engines (Up) Down.....	21"/ 32"
Displacement ½ Load.....	13,279 lbs
Fuel tank.....	250 gal
Fresh water tankage (including hot water tank).....	58 gal
Holding tank.....	25 gal
Air height above water to top of radar dome mounted on hard top.....	8' 11"

1 INTRODUCTION

1.1 PURPOSE AND LIMITATIONS

This purpose of this Owners Guide and the equipment suppliers' manuals in the accompanying binders is to provide you with an overview of the yacht's equipment, operation, systems and maintenance. The people at MJM and Pamlico Yachtworks have taken pains to edit this guide for accuracy in good faith.

Most of these topics require further study and learning by the captain of a vessel who assumes extensive responsibilities for safe operation of the vessel and for safety of the crew.

This summary guide of yacht equipment and operation will never be complete or accurate in all respects. **And, since** we frequently make improvements, we assume no responsibility for missing information or errors contained herein. This document doesn't replace common sense nor qualify the reader in safety practices, boat handling or navigational skills. Mastering these systems and the skills of seamanship is each owner's/captain's responsibility. If this is your first yacht, or if you're changing from a different type of yacht, please get instruction and experience before assuming command. Your dealer, yacht club, marina or the US Power Squadron <https://www.usps.org> are all good resources that can recommend licensed captains, schools or other instructional entities.

Although this guide and the accompanying manuals describe systems on the boat, they don't qualify you to work on them. When they need attention, please use qualified and certified trades personnel. If you question the information or are unsure about an action, check with the equipment supplier, a qualified person or us.

The Appendix includes other useful information. And there's a chapter on the people who create MJM yachts you can contact if you need help. Study these resources to understand how to operate your yacht safely.

DANGER

The operation of a powerboat can be dangerous. Pay careful attention to safety notices in this guide and in the manuals.

Keep this guide in a secure place on the boat. If you sell the yacht, please give this copy to the new owner.

1.2 STANDARD SPECIFICATIONS

You may download the latest version of this guide and the standard specifications for a MJM35 from <http://www.mjmyachts.com/35> to install on your computer, an iPad or navigational display.

1.3 CONVENTIONS

When we reference a specific device or item of equipment on the boat, it will be in all caps, such as HOUSE BATTERY.

As we describe each device, we often use the following order.

1. BREAKER PANEL settings
2. Function, what it does
3. Directions for use
4. Advice or comments in a sidebar
5. The URL for the manual if available

This guide is published in accordance with ISO standard 10240:1995E Small Craft - Owner's Manual. Please contact us if you have a question about the material in this book, if you find a conflict between this material and the material in the binders or if you find an error or important omission on the following pages please contact customer service at Pamlico Yachtworks

...R.I.J.

2 SAFETY and some USCG REQUIREMENTS

2.1 BINDER MANUALS

The equipment suppliers' manuals in the accompanying file box have many safety notices that relate to their products, their operation and maintenance and their use in the boat. Ensure that you understand this essential information before you operate the boat. Spend time reviewing the safety procedures, how safety equipment works and where it's stowed. Instruct guests in safety procedures.

2.2 STANDARD EQUIPMENT

VHF Radio BREAKER PANEL settings: ELECTRONICS breaker on. The VHF RADIO may be used for receiving weather broadcasts, communicating with harbors, locks (ch13), bridges (ch 9), marinas, the U.S. Coast Guard (USCG), rescue services boats and other boats. The USCG monitors channel 16. If you normally have your radio tuned to channel 16 you can listen for emergency calls from nearby boats or be able to make an emergency call quickly. Don't use Channel 16 for a private conversation.

MMSI Number The radio has Digital Selective Calling (DSC). It's arguably the most important piece of safety equipment on the boat. There's a one-button emergency transmit button that sends a Maritime Mobile Service Identity (MMSI) number to the USCG. The signal identifies the boat. It's interfaced with GPS so your position will be sent with the emergency message. The Automatic Identification System (AIS) will report your MMSI number to other vessels and you will see their MMSI number. If you sell your boat, log onto your account to cancel the MMSI number, so the new owner can register, acquiring a new MMSI.

In addition to the safety function, an MMSI number is like a phone number. You can make a call to another DSC-equipped vessel if you know its MMSI number. Only the vessel being called will receive the hail.

BoatUS <http://www.boatus.com/MMSI/> is authorized by the Federal Communications Commission and the USCG to assign MMSI numbers. The *Installation and Operation Instructions* for the VHF RADIO included in the Manual explains how to install the MMSI number in your radio. It also explains how to use the VHF RADIO. It may be downloaded at:

The Horn BREAKER PANEL settings: HORN breaker on. The USCG requires a "Sound Producing Device" for signals under many circumstances. The HORN is operated from a switch on the CONSOLE SWITCH PANEL at the helm. The adjacent UNDERWAY HORN/ANCHOR switch has programmed signals. (See page 13.)

CAUTION Electronics fail. It's wise to have a portable VHF radio, GPS receiver, SEARCHLIGHT and HORN that are battery operated and hand held.

Fire Extinguishers See *EMERGENCY DIAGRAM* page 5 for Fire Extinguisher locations when the boat is delivered.

Carbon Monoxide Detector See *EMERGENCY DIAGRAM* page 5.



To send a distress call (without specifying its nature) press and hold the red distress key for 3 seconds. See *Operation Instructions*.

Companionway Hatch Board or Closure A companionway board with the label "DON'T REMOVE WHILE UNDERWAY" is provided to comply with ISO requirements for cockpit draining and to prevent large waves from crashing down into the cockpit, running forward and entering the interior of the boat if the companionway door is not securely closed.

Better to just secure the companionway slider and lid. It's quieter, prevents someone from being pitched below and provides a Chart Kit navigation surface.

---R.I.J.

2.3 COMMISSIONING PACKAGE SAFETY ITEMS

The Commissioning Package Option, if purchased with your boat, will have:

- A copy of the *U.S. Department of Homeland Security United States Coast Guard Navigation Rules* to be on board. It also may be downloaded at: <http://www.navcen.uscg.gov/pdf/navrules/navrules.pdf>
- A First Aid Kit
- Nine wearable USCG approved personal flotation devices (life-jackets) and one type IV throwable PFD
- A 12-Gauge Flare Kit
- A Hand-held Bilge Pump
- A Hand-held LED Flashlight
- Paper Charts

2.4 USCG REQUIRED EQUIPMENT

A Boater's Guide to the Federal Requirements for Recreational Boats, published by the USCG, lists required safety items. The Guide may be downloaded at: <http://www.uscgboating.org/images/420.PDF>. Check state regulations where you cruise for other requirements.

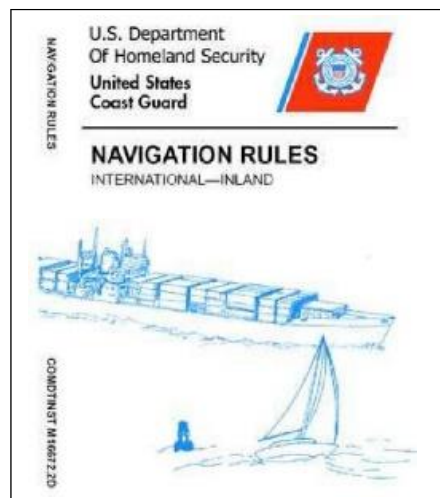

2.5 ADDITIONAL SAFETY EQUIPMENT

There are many other items of safety equipment to consider such as:

EPIRB (Emergency Position Indicating Radio Beacon) alerts search and rescue services by transmitting a coded message and is detectable by satellite anywhere in the world. Although the USCG doesn't require them, EPIRBs are essential offshore and desirable anywhere.

Inflatable Life Raft isn't required but prudent. Rafts come in compact sizes that can be stored in a cockpit locker. A dinghy isn't a substitute for a life raft.

Heaving Line is handy to have for emergency or to simply trail behind the boat (if the engines are off) attached to one of the stern cleats when people are swimming. Polypropylene is good because it floats.

A Storm Anchor is useful as a back up and for situations when two anchors are prudent or necessary.

2.6 SOME ADDITIONAL USCG REQUIREMENTS

In addition to the above safety equipment, the USCG requires:

Ships Registration and Documentation Carry the Vessel Registration, either the state-issued Certificate of Number or Vessel Documentation if federally documented with the USCG. It's wise to have your insurance as well.

Pollution Regulation Plaques You are required to post three visible placards in the boat that stipulate that waste must be managed; that oil discharge is prohibited and deposit of any refuse matter of any kind into the waters of the US is prohibited. West Marine has such plastic placards with adhesive backs that are available at little or no cost.

2.7 FUEL SHUT-OFF VALVES

The first thing to do if there is a fuel fire or leak is stop engines, turn off ignition and engine battery switches and close fuel shut-off valves by turning them perpendicular to the hose. They are located in the cockpit locker, looking forward over the generator at the back end of the fuel tank. If there is fuel in the bilges, close valves, find the source of the leak and then clean bilges.

2.8 FIRE SUPPRESSION

An automatic, heat-activated, fire suppression system is installed in the generator compartment. It can be activated manually at the helm station. To prevent the engines from evacuating the fire suppression agent when it discharges, the system will shut off blowers and generator. Refer to the manual for maintenance instruction. (note: No fire suppression system is installed if no generator is present)

Hand-held fire extinguishers (see *Emergency Diagram* page 5 for locations) are rated to fight type A, B & C fires. To extinguish a fire, first cut the source of fuel to the fire. In a fuel fire, turn off the fuel tank valves. In an electrical fire, turn off the BATTERY switches.

Fire safety begins with prevention. Reduce fire risk with these guidelines:

- Don't allow debris or oily rags to collect anywhere.
- Check bilges for oil or fuel regularly.
- Shut down unnecessary circuits when leaving the boat.
- Don't leave heat-producing appliances or equipment unattended.
- Inspect fire suppression equipment regularly and learn how to use it.

DANGER Exhaust gas contains carbon monoxide. It's colorless, odorless and lethal. Avoid inhaling. Inspect the exhaust system regularly. Idling engines at a mooring or at a dock isn't good for the engine and may allow gasses to accumulate in the cockpit or cabin.

DANGER Don't work on any mechanical or electrical equipment unless you're qualified. Electrical current and moving parts are dangerous and can be lethal.

2.9 NOTICES

CAUTION Denotes a reminder of safety practices or directs attention to unsafe practices which could result in personal injury or damage to the craft or components.

WARNING Denotes a hazard that exists which can result in injury or death if proper precautions aren't taken.

DANGER Denotes an existing extreme intrinsic hazard that would result in high probability of death or irreparable injury if proper precautions aren't taken.

2.10 EMERGENCY AND THRU HULL DIAGRAM

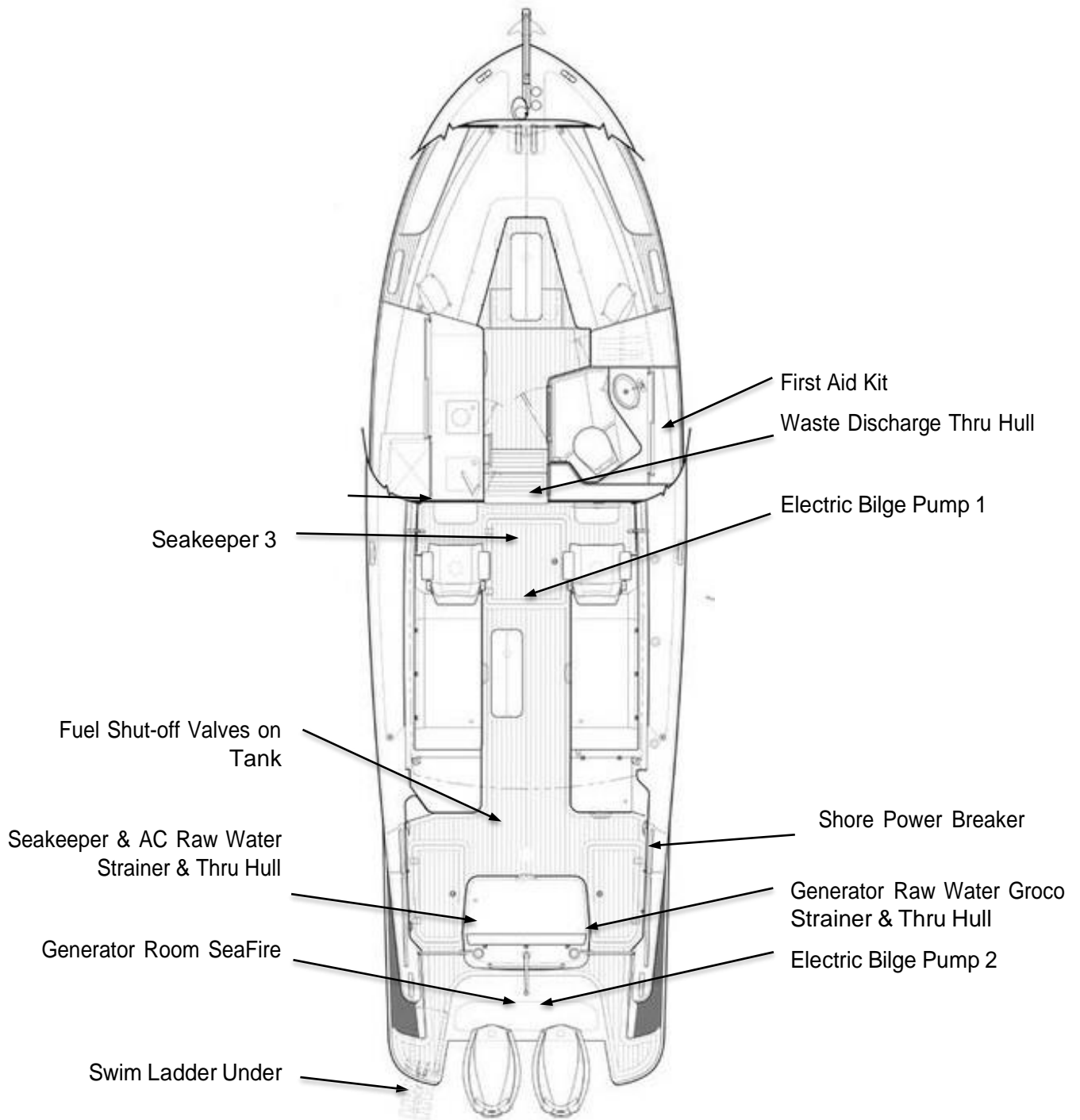

3 PROPULSION

3.1 ENGINES

The MJM 35 is propelled by twin Mercury Verado 300 or 400 HP 4-stroke, V8 or V10 outboard engines with HD heavy duty drives having either 3 blade Enertia-ECO 3-Blade or 4-blade Evolution-4 stainless steel propellers. When raised, engines are out of the water.



3.2 ENGINE CHECKS

See “Mercury Operation & Maintenance Manual (MOMM)” provided with your MJM. Before long trips, check hydraulic steering fluid level under the rear cockpit seat and engine oil level by removing the top cowl.

Top Cowl Removal to access most maintenance points. To tilt the engine closer, making this easier, use the small black AUXILIARY TILT SWITCH on the port side of the engine just below the top cowl.

Pull up on the top cowl latch on the back of the engine.

Pull the top cowl forward and lift off.

Remove dipstick on port side of engine to check oil, then securely reinsert.

Putting the top cowl back on is a bit tricky. Position the top cowl loosely in place over the engine, being sure it fits on top of the rubber seal all the way around. (MOMM says front first)..

Push down on the cowl, MOMM says back half first, then front half until it clicks into place. Make sure it's secure by pulling up on the back of the cowl. Don't want this flying off underway!

Carbon Streaks rub off with a swipe of the hand when hosing down boat.

Water Separating Fuel Filters should be replaced every 100 hours or annually. They are located on bulkheads outboard of the generator and aft of the fuel shut-off valves on top of the fuel tank.

The wire out of the bottom of the filter bowl is the sensor to alert that water is in the filter. This is not usually of an urgent nature, but rather a “change at next opportunity” event.

In-Line Fuel Filter under the engine cowl should also be replaced every 100 hours or annually. This pencil like device primarily captures fabrication debris picked up by the fuel in the tanks or hoses. Rarely does fuel clog it. (See MOMM pg 76)

Check Fuel Level The primary cause of engine failure is running out of fuel. There's a fuel level sensor in the 250-gallon tank and read out on VESSEL VIEW.

3.3 5 STEPS TO START

CAUTION Ensure there are no lines and hoses in the water near the props.

1. Turn on the PORT & STBD ENGINE BATTERY switches switch at the breaker panel inside the companionway.
2. Turn on both engine ignition keys at the top of the bulkhead inside companionway where they can't be accidentally bumped into when entering or exiting the interior.

DANGER Don't start the engine if people are in the water nearby.

3. Lower engines using the rocker switch on the port control handle. Ensure the ENGINE/SHIFT CONTROL LEVERS are in neutral. The engines won't start if either lever is in gear.
4. **START ENGINES**, push and immediately release the engine start button for each engine to starboard of the wheel. Do not hold them in as process is automatic until engine starts. If you don't hear the engines (these are quiet boats) look at the VESSEL VIEW DISPLAY panel to see they read 500-600 rpm idle. Also check to see if the Joystick base rim lights up GREEN indicating that it is active. See JOYSTICK PILOTING

CAUTION The boat may move abruptly when the gear is engaged. Ensure the boat is clear of all obstacles forward and aft. Cautiously shift to the IDLE FORWARD position then quickly back to NEUTRAL position. Observe whether the boat moves as you expect.

WARNING If a warning light or buzzer activates, stop the engine immediately. Determine the cause and repair the problem before continuing to operate.

3.4 STOPPING THE ENGINES

Put ENGINE/SHIFT CONTROL LEVERS in neutral. Push the lower STOP buttons on START/STOP Panel. The green base of the Joystick goes out and RPMs go to “0”. Once the engines have been raised, Reverse the Start process by turning of Ignition Keys, pulling out the TPS fob (and hiding it) then turning off the two ENGINE BATTERY SWITCHES.



Mercury FUEL FILTERS & Fuel Shut Offs



Engine Battery Switches



Engine Ignition Keys.



Engine START/STOP Buttons.

A reboot can solve mysterious issues. Electronic engine controls are computers. Mysterious problems emerge and may be caused by unusual switching sequence. They can often be fixed with a reboot. Stop the engines. Turn everything off—shut down the entire boat. Wait at least 10 seconds. (My printer and router call for 25 seconds.) Then turn HOUSE BATTERY and ENGINE BATTERY switches on (but not the ENGINE EMERGENCY, PARALLEL switch). Go on deck. Turn Ignition switches on at the helm. Wait until the engine control display shows data and has gone through its initial warm up. Then start the engines and check the Joystick Control functions (IPS & DPS).
...R.I.J

WARNING Engine work should not be done with the engine running unless specified by the manufacturer for a specific reason and done by a qualified marine mechanic. Stop engines before opening engine hatch.

3.5 NEW ENGINE BREAK-IN

When running the engine for the first time, frequently check oil pressure, coolant temperature (normal is 145°), exhaust color, engine vibration, sounds and the operation of indicators and gauges. Don't run the engine at a constant RPM for long periods of time or apply full throttle for more than about 30 seconds.

Lubrication During the first 10 hours of operation, high oil consumption is typical. Change oil between 50 and 100 hours. Consult the *MOMM* for the proper oils for the climate where the boat will be operating.

3.6 OPERATING PARAMETERS

Pay attention to the engine data on the VESSEL VIEW or chartplotter. A significant change in oil pressure, coolant temperature or pressure, or voltage drop should be quickly investigated before the engine is damaged. Data should read approximately:

- Oil Pressure: 50 psi at 3000 RPM or more.
- Coolant Temperature: 145° F to 165 ° F
- Coolant Pressure over 3000 RPM: 15-25 psi.
- Charging: 13-14 Volts underway

While Mercury has run their engines for 300 hours straight at max RPM without damage, a good fast cruising speed is 35-37 knots. or about about 90% of max RPM at about 5200 RPM. Listen and feel for sweet spots. If you hear abnormal sounds, stop the engine and inspect.

3.7 LEAVING THE BOAT

With SHOREPOWER connected - turn off all three-remote engine/generator switches. You may also turn off the DC MAIN breaker but keep this on if you want to keep your refrigerator operating. The charger/inverter will automatically charge all four batteries via automatic charging relays.

If moored at dock with no shore power, simply ensure both engine switches and generator switch is off, as well as the DC MAIN breaker is off. This will ensure bilge pumps remain functional while other loads are turned off. If the boat is to be dry-docked for an extended period of time with no charging, manually turn off both the port and starboard house battery switches in both of the battery compartments.

Flushing the Engines If you plan to let the boat sit for more than a few days, *MOMM* advises to flush the engines by hooking up a dock hose to the flush connector on the port side of the engines next to the auxiliary lift button and letting it run for about 15 minutes. See *MOMM* page 70. A "Y" hose connector would be helpful here to have both engines flushing at once.

3.8 MERCURY VERADO 300 & 350 HP ENGINES

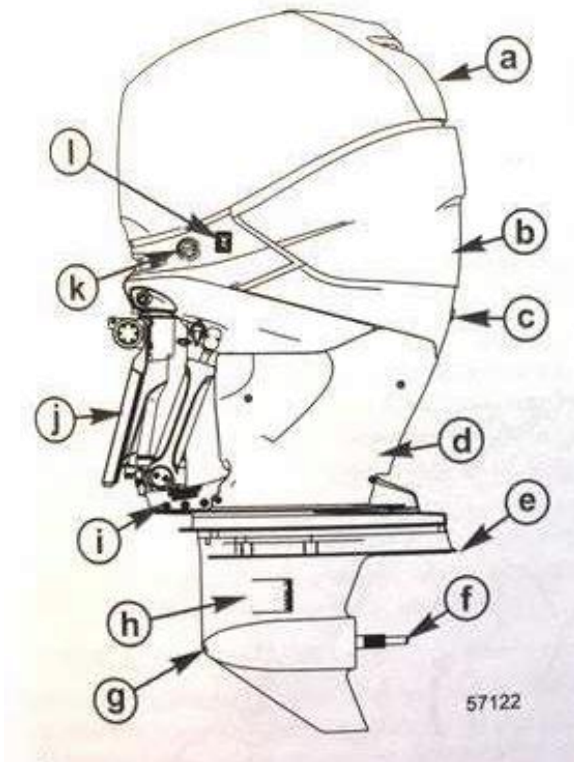

- a. Top Cowl
- b. Rear Cowl
- c. Idle Relief Exhaust
- d. Lower Cowl Chaps
- e. Anti-Ventilation Plate
- f. Propeller Shaft
- g. Low Water Intake Holes
- h. Water Intake Holes
- i. Trim Guide Plates
- j. Pedestal
- k. Engine Flush
- l. Auxiliary Lift Switch

4 INSTRUMENTS AND CONTROLS

35 power steering rotates outboards through a 20° arc. The steering is more positive and immediate than deflecting prop wash off a rudder from a propeller on a straight shaft and far more positive than directing a jet of water at water passing the hull..

...R.I.J.

The following material includes selected summaries of the Volvo Penta Operator's Manual (VPOM) included in the binders. Please read the entire manual for safety instructions. There are frequent page references to the VPOM in the following paragraphs.

4.1 HELM STATION

Most of the boat's controls and instruments are at the helm station. Below is the layout on Calypso #31. Helm layout may change. The respective circuit breakers must be on for the equipment to operate.

- 1 Ritchie Compass
- 2 Chartplotter
- 3 Mercury VesselView
- 4 Console Switch Panel
- 5 12v & USB outlets
- 6 Garmin MFD
- 7 Seakeeper Control Panel
- 8 Searchlight Control
- 9 Mercury Joystick Piloting
- 10 Autopilot Button
- 11 ZipWake Auto Trim
- 12 Engine/Shift Control Levers
- 13 Engine Stop Lanyard
- 14 Pilothouse Light Switches
- 15 Bilge Pump Controls (2)
- 16 Generator Start/Stop
- 17 Engine Start/Stop
- 18 Windlass Up/Down
- 19 High Water Alarm
- 20 Fire Suppression Alarm
- 21 Bowthruster Controller
- 22 Mercury Diagnostics Port



Aesthetic Riser (Option) This 4" high removable riser improves visibility for someone shorter than 5'5". It locks into place with a barrel bolt and can be stored in one of the settee lockers.

4.2 MERCURY FEATURES AND CONTROLS (PAGES 56 -77)

4.3 JOYSTICK PILOTING

The Mercury Joystick Piloting functions very much like the Volvo Penta IPS, except it's more automatic.

MOVE Engine Controls to Neutral. The ring at the base of the JOYSTICK lights up Green to show that it's active.

TWIST Joystick to turn the boat or LEAN Joystick in direction desired or do both at same time While PUSHING Joystick forward or aft... without going back to center.

PUSH ADJUST "+" for 100% torque (shows 2 lights).
PUSH "-" for 50% torque (1 light). "+" is recommended.

ENGAGE Engine Controls to deactivate.

4.3.1 AUTOPILOT Press boat outline button (Lower Left of Joystick) to engage Autopilot.

TAP Joystick port or starboard to alter course by 1-degree increments. Beep confirms.

TWIST and RELEASE to alter AP Course in 10-degree increments.

In an emergency, you can forcibly TURN the wheel to disengage the autopilot

4.3.2 WAYPOINT TRACK Press "Tri-circle" diagram on starboard side of joystick to set course to WP-1 of course plotted on Raymarine display. Upon arrival at WP-1, there will be an audible beep. Push "Tri-circle" button again to set course to WP-2, etc.

4.3.3 SKYHOOK PUSH "SKYHOOK" button to hold heading and GPS position. GREEN necklace turns BLUE to indicate it is active. Seakeeper gyro helps greatly here, too, so waves don't readily throw the bow around.

4.3.4 BOWHOOK With SKYHOOK activated, PUSH "Bowhook" on Vessel View screen to hold GPS position, but unlock compass heading allowing boat to point into direction of wind/current so engines don't have to work so hard to keep boat in position. See illustration at right.



4.4 DISPLAYS

The Mercury VESSELVIEW 703 DISPLAY panel allows the operator to perform settings and choose information to be displayed. (Refer to the adjacent VessleView 703 Quick Guide) This panel is activated when the engine ignition keys are turned on.

The chartplotter and VHF radio are activated by turning on the ELECTRONICS breaker on the 12V ELECTRICAL PANEL. Turn on any other equipment that you plan to use that have independent switches. Verify that all the navigation instruments are functioning as expected before you leave the dock.

Boat Speed over ground (SOG) may be displayed in the bar at the top of the MULTI FUNCTION DISPLAY (MFD). Or on VESSELVIEW. SOG is derived from tracking GPS positions rather than a paddle wheel or sonic device. SOG from the same source may be chosen for display in large digits on the MULTIFUNCTION display. Wind and current affect speed over ground and SOG isn't the same as speed through the water. If you learn to approximate speed through the water from RPM on the tachometer, you can compare it to SOG to determine the effect of wind and current.

4.5 COMPASS HEADING AND CALIBRATION

The yacht is equipped with three devices that display bearing:

1. The RITCHIE COMPASS on the dash
2. A Digital compass
3. The GPS COG (Course Over Ground) on the MFD or VESSELVIEW

When you are underway, these three sources should agree within a degree or so. If they don't, employ a professional compass adjuster. The DIGITAL COMPASS SENSOR is located aft (a puck) on the hard top.

Caution Don't store ferrous items such as tools near the digital or Ritchie compass.

4.6 TRIMMING THE 35

Trimming a 35 is somewhat of an art form as there are 3 WAYS to do so and they are inter-related. The boat seems to run fine just trimming the outboards with the autotrim systems off.

4.6.1 ENGINE TRIM WITH no side wind or leaning of the boat to port or starboard, there's not much more necessary than adjusting a comfortable bow up or down angle using the buttons on the ENGINE CONTROL LEVERS to change the angle of the outboards.

4.6.2 MERCURY ACTIVE TRIM (See following description) can automatically do the same, adjusting the outboards to your boats loading and your ride preference.

4.6.3 ZIPWAKE AUTO TRIM On the 12v BREAKER PANEL, Turn TRIM TAB breaker on. This activates the ZIPWAKE automatic or manual leveling system. See the attached ZIPWAKE Operator's Quick Guide. The degree to which the interceptor blades are lowered is shown by the two angled bars at the bottom.

CAUTION It's possible to have dueling trim systems. If the boat is running level, and the ZIPWAKE does not respond to raise the bow higher in seas, you'll note that blades are fully retracted, so engines must be raised to correct trim.

4.7 SEARCHLIGHT

BREAKER PANEL settings: SEARCHLIGHT breaker on. Turn on the light by depressing the on/off button.

The SEARCHLIGHT is a powerful LED appliance that may be operated with a joystick from the helm. The LEDs draw less power (only 2.8 amps at 13.8V) than previous incandescent devices.

With the joystick on the dash control, rotate your light to the desired location.

The speed of the light rotation can be controlled by depressing the fast/slow button once and by depressing it again to restore the original speed. The hard-wired dash control will be backlit when the bulb is illuminated.

4.8 MULTIFUNCTION DISPLAY (MFD)

BREAKER PANEL settings: Turn Electronics breaker on.

The primary purpose of the MULTI FUNCTION DISPLAY (MFD) is to show depth in big numbers. The depth transducer is installed on the hull just aft of the generator. Depending on loading, speed and wave action it's about 1.3 feet below the waterline.

The MFD may be calibrated to show the water depth from the boat's waterline or from the bottom of the propeller. However, we do not recalibrate depth settings during sea trials and recommend keeping the 1.5-foot safety margin rather than recalibrating. The bottom can come up fast and it's helpful to buy seconds to react.

4.9 CONSOLE SWITCH PANEL

BREAKER PANEL settings: Turn on breakers for the CONSOLE switch panel functions you plan to use. Turn on the WINDLASS breaker and the FRESH WATER PUMP breaker to enable the ANCHOR WASHDOWN and the WINDSHIELD WIPER/WASHER.



Windshield Actuators Two switches operate the electric synchronous actuators that open the windshields (option). Assure latches are unlocked before operating.

Horn Press to sound the horn.

Navigation lights Press up for red/green Navigation lights, press down for the anchor light, middle is off.

Windshield Wipers Up and down buttons change the speed of the wipers, the top button controls the windshield washer.

Anchor Washdown Press down to activate the anchor washdown while the anchor is being retrieved.

Windlass Press up to deploy your windlass and down to retrieve it.



POWER OPERATING WINDSHIELD

4.10 WINDSHIELD OPERATION

Manual Front Windshield While the double manual windshield design creates individual windows that are easy to lift, a stick with a rubber tip is a handy way to raise or lower the windows without having to stretch over the console.

Power Opening Windshield (option) BREAKER PANEL settings: ELECTRIC WINDOWS breaker on. Lineal actuators open the windshields.

The optional power windows may be opened to any angle by electric powered lineal actuators. If they are left closed for some time, they tend to stick and then pop up when opening. The remedy is to coat the gasket with Teflon grease, such as Snap & Zipper Lube. The windows shut with a solid thunk. It's not necessary to dog them down at the bottom except in the roughest weather, even when leaving the boat.

Caution

Do not leave windshield open when travelling greater than 10mph.

5 ELECTRICAL SYSTEMS

DANGER

AC and DC electricity can be lethal. Don't work on the boat's electrical system if you aren't a qualified marine electrician.

5.1 ELECTRICAL SAFETY

Please read and understand the safety precautions in the included National Marine Manufacturers Association (NMMA) publication, *Sportfish, Cruisers, Yachts: Owner's Manual* concerning electrical safety. For more reading, there is *Boatowner's Mechanical and Electrical Manual* by Nigel Calder and *Boat Owner's Illustrated Electrical Handbook* by Charlie Wing.

5.2 ELECTRICAL POWER

The MJM 35 includes both 12-volt direct current (DC) and 120-volt alternating current (AC).

12-Volt DC Most of the boat's electrical devices use 12V DC. It's stored in AGM absorbed-glass mat no-maintenance batteries as follows:

- Two Group 4D, 220 amp-hour HOUSE BATTERIES
- Two Group 27,66 amp-hour OPTIMA Blue-Top PORT and STBD ENGINE BATTERIES (the generator is started from the port starting battery)

The Victron INVERTER/CHARGER is factory set for AGM batteries.

CAUTION

Don't try to open the batteries. Other than keeping them charged, stored and clean (especially between the terminals), there's no maintenance required.

CAUTION

Don't let the voltage fall below 12 volts. Sensitive electronics may fail to function.

120-Volt AC Two different sources can provide 120V AC to the INVERTER/CHARGER to charge the batteries and provide power to the 120V AC circuits.

1. SHORE POWER
2. The 3.5kW Westerbeke generator (option)

120-volt AC power provides power for the COOKTOP, MICROWAVE, TV, AIR CONDITIONING, WATER HEATER and OUTLET/RECEPTACLES. There are two GFCI outlets on the boat, one in the galley and one in the head. They serve all outlets downstream of the device so all outlets have GFCI protection. If an outlet isn't working and the breaker is on, be sure to double check the GFCI to make sure it has not tripped.

The GENERATOR and SHORE POWER provide power to the INVERTER/CHARGER that charges the batteries and provides power to the 120V AC circuits in the 120V breaker panel. When unplugged or the generator is off, the inverter will only power the outlets, microwave, and cook-top.

Only one GFCI OUTLET/RECEPTACLE is in the circuit with other non-GFCI outlet/receptacles. If the 120-VOLT BREAKER on the electrical panel is on and there is no power at the AC OUTLET/RECEPTACLES, the circuit interrupter may have tripped. Press the reset button on the GFCI OUTLET/ RECEPTACLE.

...R.I.J.

5.3 SHORE POWER

The single 50-foot, 30 amp shore power cord is plugged in to SHORE POWER INLET outboard of the cockpit seat to port .

Charging The batteries will accept a charge from 120V shore power through the INVERTER/CHARGER if SHORE POWER is on even if the HOUSE DC MAIN is off. Similarly, both starting batteries will also charge if their respective switches are off

CAUTION

If you overload the shore power circuit and trip the breaker you may reset it by pushing the reset switch in the SHORE POWER BREAKER BOX. It's outboard in the starboard battery compartment or under the starboard settee hatch. However, this should never occur as the Victron charger/inverter will compensate for an overload by temporarily drawing power from the batteries and inverting for the duration of the overload.

5.4 FUSE LOCATIONS

(See the Appendix)

5.5 24-HOUR CIRCUITS

The fuse block for the 24-hour circuits is against the bulkhead behind the helm. The 24-hour circuits bypass the breaker panel, they consist of the power for three remote battery switches, bilge pumps, charging relays, and stereo memory.

5.6 THE 12V DC PANEL

The 12V DC panel includes circuit breakers for all 12V DC equipment except the 24-hour circuits that are permanently connected to the HOUSE BATTERY. The breakers are backlit and labeled.



All three battery systems are displayed on the multimeter. #1 is port start battery, #2 is the house batteries, and #3 is stbd start battery

The 150A DC MAIN breaker provides power to all of the breakers in the panel (and the solenoid power for all of the larger circuits on the boat)

The remote Port Start and Stbd Start switches turn on the respective engine start batteries. There will be no voltage reading on the multimeter until these switches are on. The Genset Start switch turns on power from the port starting battery. The Port Start switch does not need to be on in order for the Genset Start switch to be used

5.7 THE 120V AC PANEL

The 120V AC panel receives power from the Victron Quattro charger/inverter, and in turn, the charger/inverter receives power from the shore power inlet or the generator. There are two main 40A breakers on the power labeled "SHORE/GEN" and "INVERTER". The SHORE/GEN breaker provides power to the HVAC equipment and water heater. Power must be supplied from the shore power or generator in order for these circuits to be active. The INVERTER breaker provides power to the cooktop, microwave, and both forward and aft outlet circuits. These are powered constantly by the Quattro's inverter output. The multimeter also shows the voltage available on both circuits

WARNING The 120V AC panel has reverse polarity indicators. If an AC supply is wired incorrectly, either aboard the boat or shore side, a dangerous shock situation could exist. If the reverse polarity lights are illuminated, disconnect that source of power and engage a qualified marine electrician and notify the marina dock master if in a slip.

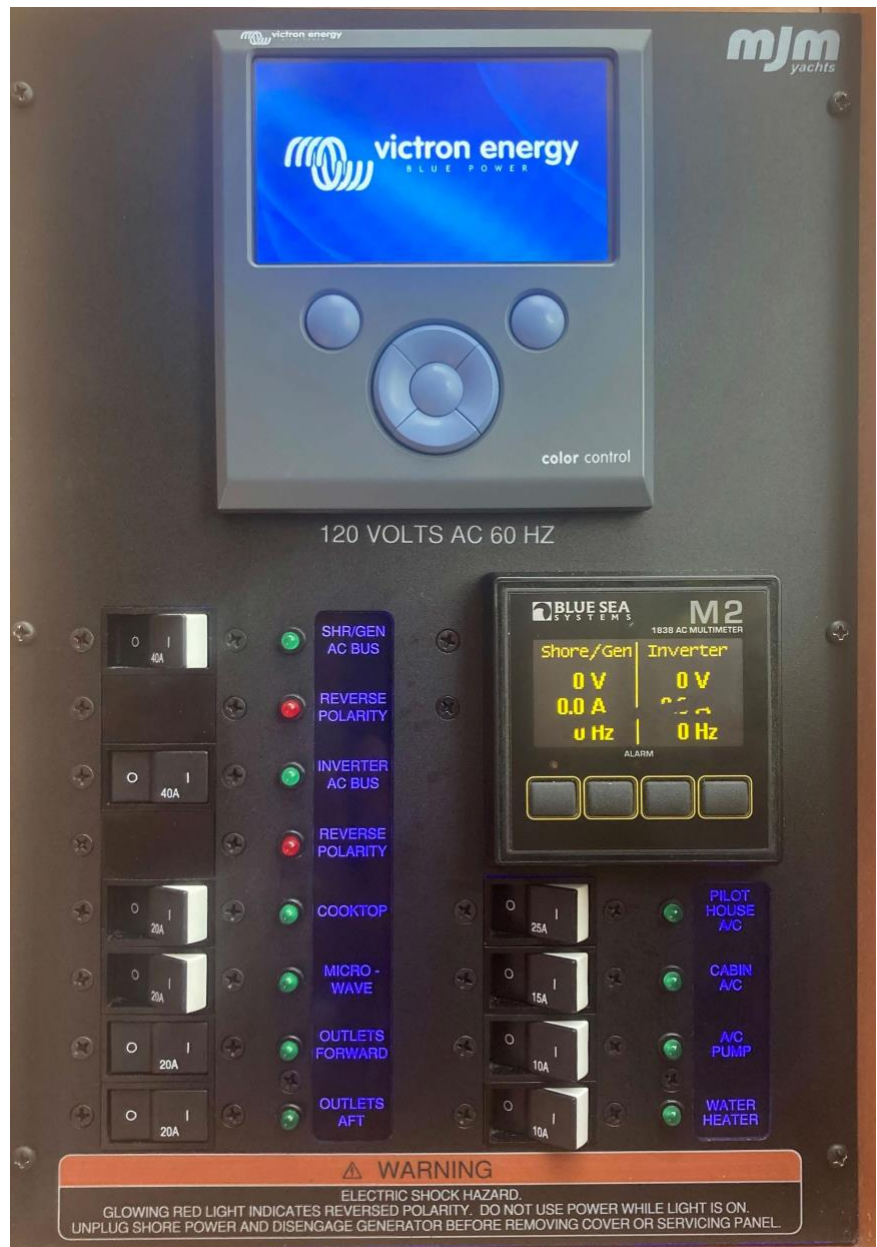

The OLED multimeter displays both the Shore/Gen power bus and the inverter bus voltage and amperage.

The Color Control GX screen is also located on this panel. Use this controller to monitor and change settings on the Quattro charger/inverter.

5.8 WESTERBEKE 3.5 MCGA GENERATOR (OPTION)

5.9 The Westerbeke Operator's Manual is included in the file box.

Pre-Start Check List The daily pre-start checklist:

1. Close seacock, clean the sea strainer (the cap should be hand tightened) and reopen the seacock.
2. Check the coolant. See diagram attached.
3. Check that the oil level is at the "FULL" mark on the dipstick.
4. Look to see that there are no loose belts or wires and that there is no oil or fuel in the pan under the GENERATOR.

Caution Do not remove radiator cap from a hot engine

To Start Turn on the GENERATOR BATTERY switch at the upper right of the 12V DC panel. Push both SLIDING INTERLOCKS up on the 120V AC panel and turn on the GENERATOR breaker at the left side of the 120V AC panel to connect the left side of the panel to generator power.

Press the Rocker switch to the start position and release. The engine will crank and start electronically after a brief delay. A GREEN LED on the switch will indicate that the engine is running.

Keep the Genset Start switch on while the generator is running

After the generator starts, the charger/inverter will automatically power up loads and start charging the batteries. (if shore power is still plugged in, power will continue to be drawn from the dock until it is turned off or unplugged)

If the generator starts but no AC voltage is seen at the panel, ensure that the GENERATOR breaker is on. This is located on the front of the generator itself. If so, there is a possibility the generator was overloaded. See Westerbeke Manual.

To Stop Turn off breakers for 120V loads and run the generator for 2 or 3 minutes without a load to allow it to cool. Press the rocker switch and release. The Green light will go off.



GENERATOR FUEL PRE-FILTER is behind the generator against the bulkhead

5.10 GENERATOR COMPONENT LOCATIONS

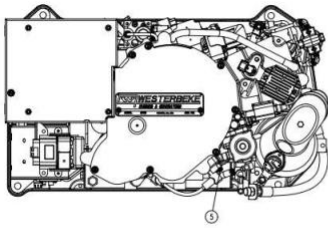

TOP

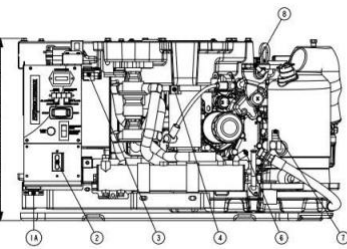
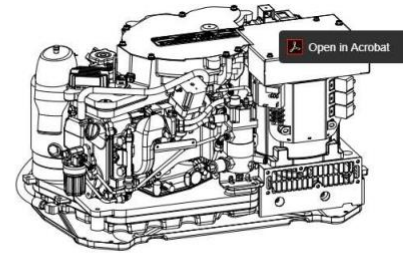
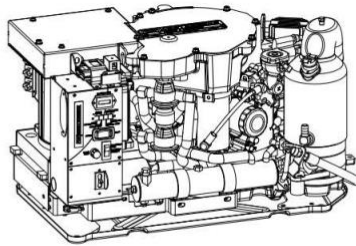

SERVICE SIDE

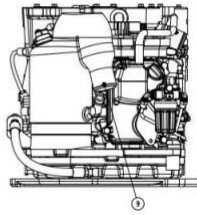

EXHAUST END

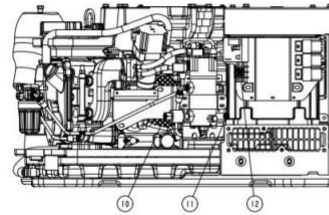

NON-SERVICE SIDE

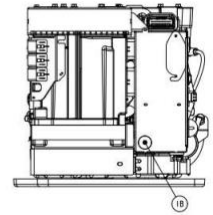

GENERATOR END

ITEM	CONNECTIONS
1A	AC POWER
1B	AC POWER (OPTIONAL)
2	A/C CIRCUIT BREAKER
3	REMOTE PANEL
4	BATTERY (NEG), CONNECTS TO STARTER GROUND STUD
5	BATTERY (POS), CONNECTS TO STARTER SOLENOID
6	RAW WATER OUTLET (TO SIPHON BREAK), REQUIRES 1/2 IN ID HOSE TO CONNECT
7	RAW WATER INLET (FROM SIPHON BREAK), REQUIRES 1/2 IN ID HOSE TO CONNECT
8	COOLANT OVERFLOW, REQUIRES 5/16 IN ID HOSE TO CONNECT
9	WET EXHAUST, REQUIRES 2 IN ID HOSE TO CONNECT
10	FUEL LINE, REQUIRES 1/8-27 NPT MALE TO CONNECT
11	RAW WATER INLET, REQUIRES 1/2 IN ID HOSE TO CONNECT
12	FIRE BOY

NOTES (UNLESS OTHERWISE SPECIFIED)

1. DIMENSIONS: INCH [MM]
2. TOLERANCE: $\pm .375$ [9.5]

5.11 VICTRON INVERTER/CHARGER

The Victron Quattro inverter/charger is the heart and brains of your boat's AC electrical system. It takes the role of three separate devices and rolls them into a single smart and efficient package. It functions as a 200A charging source for your 12V batteries, a 5,000w inverter for your AC electrical loads,

and an automatic hands-free transfer switch

Charging When SHORE POWER is connected to a 120 v 30-amp shore power supply or when the GENERATOR is on, the INVERTER charges both HOUSE BATTERIES, and the PORT and STBD ENGINE START Batteries via two voltage sensing relays. There are also two 135A breakers located in the forward starboard battery compartment to share the charge between the house and start batteries. Ensure that these breakers are on if a battery keeps losing charge.

Inverting This operates accessories that require 120V AC, such as the COOKTOP, MICROWAVE, TV, and OUTLET/RECEPTACLES. These circuits will remain on whenever the Quattro is on and connected to the 12v DC House batteries. Like the charging above, inverter function is automatic. Water heater and air conditioning loads are not available on the inverter output. The Quattro will turn off its inverter function if the House batteries drop below 11.8V, preventing a dead battery.

Transferring The Quattro has a built in automatic transfer switch. It will automatically connect and disconnect both the shore power and generator feeds without any user intervention. If both shore power and generator feeds are active, the Quattro will favor the shore power by default and switch to the generator when the boat is unplugged

Smart Features The Quattro also has some smart capabilities built in. For example, it is programmed not to let loads exceed the roughly 30A available on both shore power or generator. If your loads exceed this value, the Quattro will automatically take power from the batteries and turn on the inverter to add power to the AC system. For example, if the air conditioning is running along with the water heater and the load is at 30A, and you decide to use the microwave, the Quattro will automatically run the microwave from the inverter. Once the overload condition is over, the inverter turns off, and the Quattro will automatically start recharging the batteries. The Quattro can also adapt its DC charging rate to also not exceed available AC power

The controller for the inverter is the color screen located on the AC panel. From here you can monitor functions of the charger/inverter as well as set different parameters. For example, if you are at a dock with only a 15A receptacle, you can "dial down" the AC input amps on the controller and prevent the Quattro from exceeding the amperage available.

5.12 BONDING

The boat's bonding system connects underwater metal fittings and strainers to the sacrificial anode and the boat's negative bus bar. For the anode to protect an underwater part, the connection must be clean and secure. The green wires that make up this system don't normally carry current.



Victron Color Control GX. See the manual for more advanced functions

CAUTION

6 WATER SYSTEMS

6.1 FRESH WATER

BREAKER PANEL settings: FRESH WATER PUMP breaker on.

Fresh water is supplied from two interconnected 25-gallon water tanks under pilothouse settees, which are filled through a fitting on the starboard side deck.

No fresh water gauge is needed as you can readily see the level in the tanks.

Fresh Water Pump

A JABSCO 42755-0092 12V FRESH WATER PUMP provides fresh water pressure. The pump is in the pilothouse port settee locker. It runs when a faucet, the head, anchor chain wash, wiper wash, showers, etc., are used. It has two switches to maintain pressure in a useable range so the pump doesn't switch on every time fresh water is used. When pressure drops below the minimum, the pressure switches turn the pumps on and build pressure to the maximum. The pumps have outlet check valves that maintain pressure when pumps are off. The pump is protected from sediment by an in-line strainer mounted adjacent to the pump. Check and clean the strainer periodically.

If the pump runs continuously, a faucet might be open. The transom shower valve is a frequent culprit. If nothing is on, check that the FRESH WATER TANK has water. Then look for leaks in the lines. An air bubble in the line may defeat a pressure switch and cause the pump to fail to operate. Opening a faucet and turning the FRESH WATER breaker off for a moment and on may fix it. If that doesn't work, attach a hose to the DOCKSIDE HOSE INLET and run water through various fresh water outlets.

6.2 HOT WATER

The 750w 8-gallon HOT WATER TANK is under the port pilothouse settee. It's part of the freshwater system and doesn't need separate filling.

If you want hot water and haven't run the engine, turn on the WATER HEATER breaker on the right side of 120V AC panel. The WATER HEATER is a high-load appliance and will require the GENERATOR or SHORE POWER to be on.

There is no specified periodic maintenance, but it's wise to inspect connections and clamps periodically.

If you don't get hot water from the immersion heater, press the reset button under the white cover at the right side of tank. See sidebar and the Indel Isotemp Owner's Manual in the binders.



INDEL ISOTEMP 8-gallon HOT WATER TANK

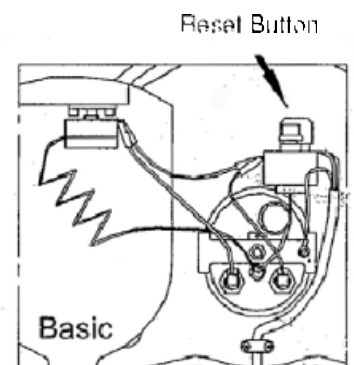

Water Purifier

The General Ecology Seagull WATER PURIFIER in the galley is an excellent water purifier. It's used on many airlines and by the military.

General Ecology, Inc., states that Seagull IV purification systems meet the EPA guide standard protocol for microbiological purifiers for bacteria, cysts and viruses and excels at removing chemical and aesthetic contaminants, including herbicides, pesticides, chlorine and foul tastes, odors and colors.

The purifier has a cartridge in a stainless pressure vessel under the sink. Replace it if reduced water flow indicates that it's clogged, if any particulates are seen in the water, if there is any taste in the water or at least annually. The filter is rated for 1000 gallons, equal to about 15 water tanks. The replacement cartridge is Seagull IV X-1 Residential Replacement Cartridge RS-1SG and can be bought online.

https://generalecology.com/category_products.php?category_name_url=n-home

CAUTION Clear the freshwater system of antifreeze before running water through the cartridge.

6.3 GRAY WATER

A GRAY WATER SUMP BOX collects water from the shower drain, air conditioner condensate, and refrigerator condensate. Gray water can be legally discharged overboard. The sump pump switch on the 12V DC panel provides power to a pump with a float switch to empty the tank. It runs to the stbd fwd through-hull. Remove the tank cover and clean tank and strainers periodically.

The Gray water sump box is located below the bottom companionway step.



GENERAL ECOLOGY SEAGULL
WATER PURIFIER

*Mary and I credit our good health to
using this system in all our boats and
homes for the past 37 years.*

...R.I.J



GRAY WATER SUMP

Bilge Pumps There are two electric bilge pumps. They are located:

- Aft in the SEAKEEPER compartment
- Aft in the central cockpit compartment at the transom



Aft BILGE PUMP

They are wired directly to the 24-hour fuse panel so they function even if the DC MAIN breaker is off. (See 24-Hour Circuits, page 16.)

Three 3-way switches at the helm control the pumps. (See page 10.) The pump will run in the AUTO position if water is present. The pump will run in the MANUAL position whether there is water in the bilge or not. Please ensure that the switches remain in the "Auto" position anytime the boat is in the water.



BILGE PUMP SWITCH

6.4 RAW WATER

Raw Water (seawater) is used for heat exchange for the GENERATOR, optional SEAKEEPER and the AIR CONDITIONER. Two raw water strainers and seacocks with shutoff valve, double clamped to its hose, have a strainer that should be checked regularly.

7 SEAKEEPER GYROSTABILIZER (Option)

The SEAKEEPER is a 550 lb. sphere that spins up to 8,450 RPM. It's anchored to a reinforced structure low in the boat to resist roll.

Following is a summary of the Seakeeper 3 Gyrostabilizer (GYRO) operation. Please review the details of operation and the safety notices in the Seakeeper Operation Manual in the binders. You can download a copy at:

<http://www.seakeeper.com/technical-library>.

Before you start the GYRO, check its raw water strainer to ensure that the cooling water intake to the GYRO is clear.

7.1 TO START THE GYRO

With the DC MAIN breaker on, turn on the 15A Seakeeper and 15A Seakeeper pump breakers on the 12V DC panel. The display at the wheel will initialize and the HOME screen will appear. If a FAULT is present an ALARM screen will appear. There is also a 12V 100A breaker in the forward part of the starboard battery compartment that provides power to the Seakeeper itself. Ensure that this breaker remains on. The 15A Seakeeper breaker in the panel powers the automatic switch for the Seakeeper circuit.

Press the POWER ON/OFF button once. The BLUE PROGRESS BAR begins to move, and the GYRO begins spinning . It takes about 35 minutes before the GYRO is ready for stabilizing.

7.2 ACTIVATE/DE-ACTIVATE

Press the lower GYRO ON/OFF panel on the screen (the panel turns from gray to blue) It takes 5-10 seconds to activate.

Press GYRO ON/OFF button (the panel turns gray) to deactivate the GYRO.

CAUTION There is a large amount of torque about the gimbal axis when the GYRO is processing. Cover panels protect the GYRO while it's in operation. Don't stand on them or put anything on top. The covers should always be in place during operation. No maintenance should be attempted unless the gyro is locked and the flywheel has stopped spinning.

8 EQUIPMENT, APPLIANCES and FINISHES

8.1 ANCHOR WINDLASS

BREAKER PANEL settings: DC MAIN, FRESH WATER PUMP and WINDLASS breaker on. Also ensure that the 80A breaker located in the forward starboard battery compartment is also on. The 5A breaker in the DC panel powers the automatic switch for the windlass circuit.

To retrieve the anchor, use the engine to move the boat over the anchor, not the windlass; it's sized to retrieve the anchor and rode, not pull the boat. If the anchor is lodged, motor over the anchor to break it loose, then retrieve it with the windlass.

Stop the windlass before reversing its rotation, otherwise the windlass fuse may blow, or the breaker may trip. Refer to the windlass manual in your binders for specific operating instructions.

The WINDLASS can be operated from the WINDLASS switch at the helm.

<http://www.muir.com.au/product-page/6145c752-d6cb-2bea-5d0e-6d4ab1547832>

CAUTION When anchoring, don't rely on the windlass to hold the anchor rode. Remove the rode from the anchor chute and feed it through a bow chock to a bow mooring cleat to avoid chafe on the anchor rode and to avoid damaging the windlass gears.

CAUTION When underway or when leaving the boat, secure the anchor and chain with the retainer clamp. This prevents the anchor and rode from running free and fouling the props. If the anchor chain slips, use the winch handle in the top of the windlass to tighten.

8.2 ANCHOR WASHDOWN

A spray nozzle under the anchor roller washes salt water and mud from the anchor rode and chain as the anchor is raised when the rocker switch at the CONSOLE SWITCH PANEL is pressed. (See page 13.)

8.3 FUSION MULTI-MEDIA PLAYER

BREAKER PANEL settings: Stereo and Stereo Amp breakers on.

See the instruction manual in the binders for operating instructions and for connecting to Internet media services.

<https://www.fusionentertainment.com>



MUIR Anchor Windlass

There is good advice on anchoring and retrieving lodged anchors at <http://fortressanchors.com/resources/safe-anchoring-guide>

...R.I.J.



FUSION MULTI-MEDIA PLAYER

8.4 PRIVACY/SUNSCREEN CURTAINS (OPTION)

The optional PRIVACY/SUNSCREEN CURTAINS provide privacy so the pilothouse can serve as an additional stateroom.

The two large side curtains roll up in place. The other curtains roll up in a carry bag. The aft and windshield curtains hook up inside. An advantage of inside curtains is that they don't get dirty or need storage when wet from dew when departing in the morning.



One good way to roll up the curtains is to lay them over the top of the pilothouse table. Roll all sections up together and put them in the storage tube. Don't fold them.



PRIVACY/SUNSCREEN CURTAINS



COOKTOP

8.5 COOKTOP

BREAKER PANEL settings: COOKTOP breaker on. The COOKTOP has flush-mount, pop-up, heat-resistant rubber potholders. You must push on them for several seconds for them to respond. Refer to the *Installation Guide & Operation Manual* included in the binders.

CAUTION Don't leave an unattended cooktop on.



MICROWAVE

8.6 MICROWAVE

BREAKER PANEL settings: MICROWAVE breaker on.

Refer to the *Owner's Manual* for operating instructions and precautions



REFRIGERATOR

REFRIGERATOR

12v DC BREAKER PANEL settings: REFRIGERATOR breaker on.

The thermostat has an on/off button and a temperature adjustment button. Each time the temperature adjustment button is pressed, the LED indicator advances from left to right indicating a cooler setting.

It can take a while for temperature to stabilize, particularly after initial stocking with food and beverages.



ICE MAKER

8.7 Aft Refrigerator or ICE MAKER

12v DC BREAKER PANEL settings: Galley Fridge and Aft Fridge breakers on.

The built-in freezer box has stainless steel inner lining, plastic bottom section, wire basket and interior light. It has a range of 0 °C to -20 °C. <https://www.indelwebastomarine.com>

8.8 TV (OPTIONAL)

120v AC BREAKER PANEL settings: Aft Outlets on.

See the manual in the binders. The picture in the sidebar is of an optional TV installation in the Pilothouse.



DROP DOWN 32" TV

Video signals may be acquired from the Fusion player or from other devices you choose.

Depending on options you select, Surround-Sound may be achieved using the AUX function at the FUSION MULTI-MEDIA RECEIVER to integrate both TV Audio and the six-speaker stereo audio. Or kids can watch TV with dedicated audio below decks while parents are listening to jazz, with the "Fade" function directing sound to the two cockpit speakers.

8.9 VACUUM FLUSH HEAD SYSTEM

DC BREAKER PANEL settings: FRESH WATER PUMP breaker and HEAD breaker on.

Press the Before Use button to add water until desired water level is achieved. (It will shut off automatically to avoid overflow.)

Press the After Use button down for a moment, then release it. It activates a macerator pump that pumps water and waste from the bowl, macerates, and propels the effluent to a 22-gallon waste tank. The water level in the bowl can be adjusted on the dial on the backside of the controller.

The level of waste in the holding tank can be seen by looking forward in the starboard settee locker. A black water tank sender is installed and when the holding tank is full, the control panel will glow red and prevent flushing, and in turn wastewater spillage. Waste is discharged in one of two ways:

1. Pumped out at an authorized pumping facility from the WASTE deck fitting.
2. Discharged overboard with the DISCHARGE PUMP. Open the large through-hull discharge waste valve, accessible under the companionway step (you may need to remove the handle lock) and turn on the Macerator breaker. Waste discharge regulations vary by location.

Ensure compliance with federal, state and local regulations before discharging.

WARNING Normal household toilet tissues don't dissolve or flow well in low water consumption toilets. These tissues build up in a tank and eventually the toilet system fails. Use rapidly dissolving single ply Scott tissue. To determine that a tissue will dissolve, immerse a square of tissue in a jar of water and shake five times. It should disintegrate.

8.10 AIR CONDITIONING (OPTIONAL)

BREAKER PANEL settings: Cabin and/or Pilothouse A/C breaker, A/C Raw Water Pump Breaker

There is a 16,000 BTU heat pump that heats or cools the pilothouse and an 8,000 BTU heat pump that heats or cools the cabin. They use raw water (seawater) much like the engines, for heat exchange. The heat exchangers extract heat from the refrigerant for the cooling cycle, and by reversing the flow of refrigerant they extract heat from seawater for heating. The heating cycle is effective if the sea temperature is above 35 degrees.

There's an intake seacock, RAW WATER strainer and pump located in the cockpit seat locker and port cockpit sole locker aft. They should be checked frequently and are the first things to check if the unit fails to deliver heat or cooling.

Programming Procedure There's a wide range of options for controlling the AC system. You can set it to heat mode, cool mode or automatic mode; set it to cycle on and off for humidity control when the boat is unused; control fan speeds, view service history and hour meter and set



many more options. For a full explanation of the options, controls and the programming procedure, see the user's manual.

Programmable Parameters The default parameters may be changed. Once new values are entered and memorized, the factory defaults are overwritten and the new parameters become the default values. You can restore the original factory default parameters manually. A summary of the parameters, the permitted values and original factory default settings are listed in Table 2, page 12 of the manual in the binders. When used with optional electric heat, the fan remains on for four minutes after the heater cycles off even if fan is set to cycled operation.

8.11 FINISHES

Hull paint The 35 hull is painted with urethane paint. Wash boat with a marine boat wash using a soft sponge.

Corian Instructions for maintaining Corian counter tops are in the binders and at: http://www.dupont.com/products-and-services/construction-materials/surface-design-materials/brands/corian-solid-surfaces.html?src=gg-kg_surfaces-us_corian&gclid=CP2jrr3Vx9ECFVg6gQod2AkK0g

Strataglass Don't use chemicals or brushes to clean; use only mild soap and a sponge or a soft rag. If the curtains are scratched a mild polishing compound can be hand applied to remove them. Test a small, unobtrusive area first. (See the Strataglass Care and Maintenance website.)

<http://www.strataglass.com/strataglass-care-and-maintenance>

It's best to leave the curtains in place, even when trucking. If they're removed, store them flat or rolled together with towels or paper between layers. To avoid creases, don't fold.

UltraLeather Upholstery The standard UltraLeather upholstery is water resistant, but don't use chemicals or brushes to clean, only mild soap and a sponge or a soft rag.

Stidd Seats See <http://stidd.com/support/> for maintenance recommendations. The Stidd seats swivel and lower for a sociable setting. Slide the seats forward before swiveling so the seat doesn't jam into the pilothouse walls.

*Gull droppings on the hardtop that
drizzle down the side curtains after a rain
or heavy dew have an acid that can,
over time, etch the Strataglass curtains.
Be sure to clean frequently. There is one
known instance with a 36z that was
moored in Chilmark on Martha's
Vineyard.*

...R.I.J.

9 APPENDIX

9.1 THE TOP 10 CAUSES OF ENGINE FAILURE

It doesn't happen often and if you're familiar with the common causes of engine failure you can cut down on the chances of a breakdown. We want to familiarize you with this list, compiled by *Motorboating Magazine* (February 2006) and embellished with a few MJM incidents. Here are the Top Ten.

...R.I.J.

No Fuel This is probably less of a problem on a fuel-efficient MJM than on other boats, but lack of owner attention to fuel consumption is the primary culprit for engine failure. A boat's fuel tank can be nearly dry – even when the gauge claims there's 1/4 of a tank left. This makes sense when you realize that at cruising speed, the gauge shows the tanks reading higher than when the boat is at rest. A good rule is to not pass a fuel dock (no matter the price) if your gauge shows less than 1/3 full.

Air in Fuel Line If air gets drawn into the fuel lines because of either a small leak in a fuel line connection or the Racor Filter lid gasket/filter basket tabs have interfered with the lid being secured fully, you may find the engine will turn over, but won't start. Check the Racor to ensure the fuel level is within an inch of the top. Check the engine owner manual for the location of a manual primer pump.

Dirty Fuel Engine problems are caused by dirt and water in the fuel. Debris, stirred up from the bottom of the tank by wave action, is drawn into the fuel line and clogs the fuel filter element. Starved for fuel, the engine begins to run poorly, or won't reach proper RPMs. Water in the fuel can drive you mad. Moisture condenses out of the highly humid air on the inside walls of a fuel tank, then runs down into the fuel. Water can also be introduced at the fuel dock from a contaminated fuel supply. Fuel floats on top of water and the fuel pickups are near the bottom of the tank. A Racor fuel/water separator protects against this by handily extracting the water. Check the bowl daily and drain off the accumulated water. For severe contamination, use a fuel-drying additive or have a service "polish" the fuel.

Tired or Damaged Water Pump Impeller As boats age or if an engine isn't operated for a long period of time, a worn-out circulating water pump is another engine killer. Impeller blades are commonly made of a rubberized material that stiffens or distorts over time and can break off entirely, reducing coolant flow and clogging the heat exchanger. Periodic engine maintenance procedures can prevent this problem. A spare is provided in the engine spares kit. Shown below is an MJM 29z impeller that would have soon failed. It was replaced during the 50-hour inspection on a boat that had not been run for 11 months.



Engine maintenance and parameters: See the Mercury operation and maintenance manual

9.3 STARTING WITH LOW BATTERIES

Each engine has a dedicated ENGINE BATTERY. They may be connected with the ENGINE EMERGENCY PARALLEL (EEP) switch. It is imperative that this switch remains normally off. Each ENGINE ALTERNATOR provides up to 115A current to charge its battery.

The ENGINE BATTERIES are also connected by a voltage sensitive relay to the HOUSE BATTERIES. When an ENGINE BATTERY reaches 13.2V the VSR closes and the ENGINE BATTERY shares charging current with both HOUSE BATTERIES and the other

ENGINE BATTERY. This VSR also closes whenever the charger/inverter is charging, thereby keeping the engine starting batteries full.

Normally when underway, both the ENGINE ALTERNATORS and the GENERATOR (if running) provide charging current to both ENGINE BATTERIES and both HOUSE BATTERIES. However, if a battery falls below 12.3V, the VSR opens to separate it from the rest of the bank. That prevents a low or shorted battery from draining the other two battery banks. For instance:

- If the PORT ENGINE BATTERY drops below 12.5V, the port VSR opens and disconnects the port ENGINE BATTERY from both HOUSE BATTERIES and the STARBOARD ENGINE BATTERY.
- If the HOUSE BATTERIES drop below 12.5V, both VSRs would open to protect the ENGINE BATTERIES.

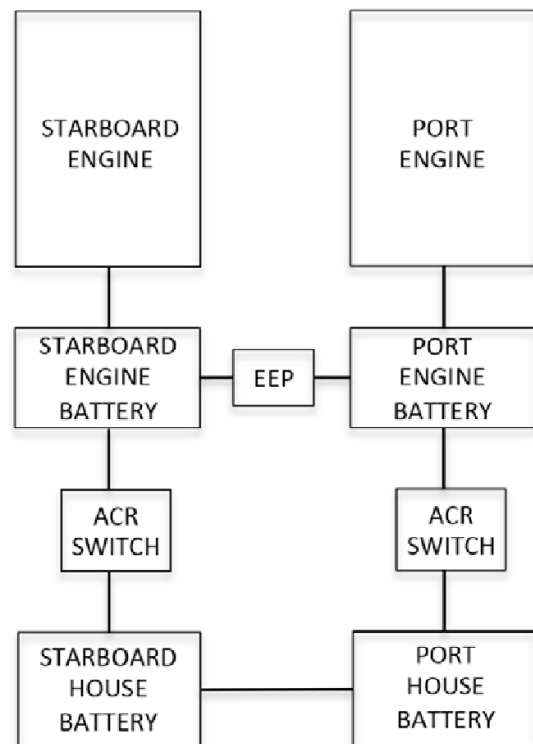

Concept diagram of HOUSE and ENGINE BATTERY connections with VSR and EEP switches

Starting engines with one low engine battery
If you're not connected to shore power and if the PORT ENGINE BATTERY is depleted and the PORT ENGINE doesn't start, start the STARBOARD ENGINE to boost the STARBOARD ENGINE BATTERY. With the STARBOARD ENGINE ALTERNATOR now charging the STARBOARD ENGINE BATTERY, as evidenced by voltage climbing, turn on the emergency engine parallel switch located in the starboard batter compartment. Then on deck, turn the PORT ENGINE IGNITION switch on. Check to see that the voltage on each engine display reads above 12 volts. If so, start the PORT ENGINE. After the engine starts, turn off the ENGINE EMERGENCY PARALLEL switch. After both engines are running, start the generator to enable the charger/inverter to start charging the batteries at a higher rate.

In the event both start batteries are discharged and shore power is not available, turn on the emergency engine parallel switch and attempt to start the generator. The generator can start on as low as 9V. Once the generator is running, ensure that the charger/inverter is running and then turn off the emergency engine parallel. The charger/inverter will then start charging the house batteries and in turn, both starting batteries. Wait several minutes until both start batteries reach 12.5V and then start your engines as normal

CAUTION These procedures are for emergencies. If a battery is low, determine the cause. All 24-hour circuits are powered from the house batteries. There are no residual loads powered from the start batteries. See if there is a charger or battery problem or if a device. If you are at the dock, don't leave until you diagnose and correct the problem. If you are at anchor or underway, you should return home or to a nearby marina if you haven't corrected the problem.



The Emergency parallel switch is located in the starboard battery compartment

9.4 WINTER STORAGE

Most facilities won't require information before hauling the boat with a Travelift or crane, but if they need advice, refer to lift points on page 39 Boat Lift and Bunk Offsets, and Hauling Out and Blocking page 36.

Review the manuals in the accompanying binders, and in particular, refer to "Short Term Storage" and "Long Term Storage" in the VPOM and consult the manuals for the GENERATOR, AIR CONDITIONING, SEAKEEPER and WATER HEATER. Check manuals for all areas needing lubrication.

For the batteries, simply manually turn off all six battery switches in the battery compartments. The automatic switches will require the user to push in on the knob to turn the switch to the "manual off" position. This will completely isolate all batteries.

Underwater hardware Power-wash the bottom and check thru hulls and seacocks for growth. (Inspection of underwater hardware may avoid a problem in the future.) Replace anodes if necessary.

Drain water Flush the engines and the generator engine and the heat exchangers with fresh water. Remove engine drain plugs to prevent freezing water from damaging the engine.

Drain the FRESH WATER TANK, WINDSHIELD WASHER, WATER HEATER, HOLDING TANK, GRAY WATER TANK, ANCHOR WASHDOWN, AIRCONDITIONER, HEAD, ICE MAKER and the plumbing lines and run non-toxic antifreeze, through the systems to purge water that could freeze.

Replace oil Drain and replace oil in engines and generator and change filters.

Engine oil drains away in storage, leaving engine components exposed and vulnerable to corrosion. Moisture and acids in old oil pit bearings and internal engine parts. Use a fogging oil to coat internal components. Warm up the engine to 185° before draining oil so heavier metal particles are picked up and flushed out.

Lubrication Find grease fittings and service them with marine grease. Most fittings are in the steering mechanism area.

Fuel Fill the fuel tank (a full tank prevents water condensation). Add fuel stabilizer to prevent deterioration.

Batteries Set a trickle charge to keep batteries topped off.

9.5 SPRING COMMISSIONING Commission engines and drives Review the manuals in the accompanying binders and in particular, refer to the VPOM and consult the manuals for the GENERATOR, AIR CONDITIONING and SEAKEEPER.

Fresh water system Commission the fresh water system: the FRESH WATER TANK, WINDSHIELD WASHER, WATER HEATER, HOLDING TANK, GRAY WATER TANK, ANCHOR WASHDOWN, AIRCONDITIONER, HEAD and ICE MAKER. Check pumps operate the systems and check for leaks.

Paint Apply anti-fouling paint to the IPS drives, the props and the bottom if needed.

9.6 HAULING OUT AND BLOCKING

Refer to the illustration titled *Boat Lift & Bunk Offsets* in *the Appendix* page 39 before lifting the boat with a Travelift or a crane with straps.

The fore and aft lift points are approximately abeam of the windshield and the aft end of the hard top respectively. Weight-bearing supports should be at the keel (centerline of the boat) and chines (edges).

CAUTION Point-loading flat areas other than centerline and chine or setting the weight of the hull on supports of insufficient area may damage the hull. A 6-8 ft. metal "V" Channel should be placed under the keel forward of the transom on top of a trailer support point between the drives to avoid point-loading the laminate.

9.7 TRAILER LOADING CHECKLIST

1. Place cockpit & pilothouse cushions below on island berth.
2. Remove canvas from bimini, detach aft legs and hinge the main hoop forward against the hardtop. Secure the short legs, pad the main hoop where it touches the hardtop (AC hose), secure the hoop to handrails with fender whips.
3. Hinge down VHF antenna and reverse tape it to starboard handrail. Hinge down running light and tighten.
4. Remove KVH or FLIR tower and seal hardtop openings and wire connections. Wrap dome and strut in blanket. Park it in a pilothouse locker, or shower, braced with throw pillows.
5. Max height over road is 13'6" if standard radar dome is bolted to hardtop without strut.
6. Wrap plastic around horn trumpets.
7. Face searchlight aft and secure the anchor chain grabber.
8. Latch all cabinet doors, drawers and fridge.
9. Don't apply adhesive tape to any surface, particularly ultra-leather.
10. Turn off all battery switches and make sure the INVERTER is off.
11. Never permit the boat to be loaded stern first or you will spend a lifetime cleaning the boat!
12. Shrink-wrapping isn't recommended. It can do damage if it breaks loose.
13. Exchange contact information with the driver and the destination yard so you may maintain contact.

-
14. In addition to aft and midship supports in locations seen on the previous page, support the boat under the bow, forward of any straps.
 15. Leaving side and aft pilothouse curtains in place best protects the boat interior.
 16. Lock companionway door. Advise driver and receiving yard on the combination.

9.9 ROUTINE MAINTENANCE

ENGINE		
Oil level	Check Daily	Change after 1 st 100 hrs., then ea. 200 hrs. or annually
Engine oil filters	50/200 hrs.	Replace after 1 st 50 hrs., then ea. 200 hrs.
Air cleaner	Check each 50 hrs.	Clean if necessary and replace
Drive belt tension/wear	Check each 14 days	Tension if necessary
Remove anodes & check	Every 100 hrs.	At each oil change or 6 months
Check valve clearances	Check 50/500	Check after 1 st 50 hrs. then 3a. 500 hrs.
Turbo charger	Every 200 hrs.	Clean blower
Mounts	Annually	Tighten
Coolant level	Check daily	Add if necessary. Don't overfill
Drive unit oil level	Check weekly	Add if necessary. Don't overfill
Valve clearance & injectors	Check	500 hrs. Adjust if necessary?
Oil in bilge	Check daily	Identify source. Correct. Clean-up
Engine area & leakage	Check daily	Identify source. Correct. Clean-up
FUEL SYSTEM		
Tanks/valves/connections	Monthly	Inspect for leaks and ease of valve operation
Racor Primary Fuel Filter	Check daily	Clean if necessary. Change ea. 200 hrs.
Secondary engine filter		Change ea. 200 hrs. or when necessary
Fuel system	When necessary	Bleed
Injectors	Check ea. 500 hrs.	Adjust if necessary?
Fuel injection pump	Check	Every 2400 hrs. Adjust if necessary?
GENERATOR		
Oil level	Check daily or 8 hrs.	Add if necessary
Oil	100 hrs.	Change after 1 st 50 hrs. then ea. 100 hrs.
Fuel Filter/water separator	Daily or ea. 8 hrs.	Check for contamination and clean
Fuel filter	Ea. 100 HRS.	Check drain and replace filter ea. 100 hrs.
Engine hoses	Weekly	Tighten and secure if necessary
Exhaust system	Weekly	Inspect for leaks. Check anti-siphon
RAW WATER COOLING		
Heat exchanger	Check ea. 2400	Clean
Sea Water strainers	Daily	Clean screen & bowl if necessary
Cooling System	Every 500 hrs.	Check & flush
FRESH WATER SUPPLY		
Water tank	Annually	Flush & clean
Water pump strainer	Monthly or less	Remove & clean
Hoses and valves	Daily	Observe leaks or note recycling of pressure system
Seagull purifier cartridge	Annually	Replace cartridge more frequently if reduced flow
GRAY WATER SYSTEM		
Sumps	Annually	In main cabin floor hatch & systems room
Automatic bilge pumps (3)	Check daily	Test with manual switch
Manual bilge pump	Monthly	Check operation
Bilge area	Check daily	Clean as needed
ELECTRICAL SYSTEM		
Batteries	Monthly	Remove lids, check for loose cables, clean
House and Engine batteries	Check voltage daily	Ensure charging system is working
Connections	Inspect annually	Clean, tighten or repair
Transom & drive anodes	Inspect quarterly	Replace if 50% eroded
MISCELLANEOUS		
Fire Suppression system	Mon/Bi-anly/5yrs	Check gauge, canister weight, replace canister
Trim tabs	Check	Remove barnacles
Bottom Paint	Monthly/annually	Repaint

The chart above is an approximation. Refer to the equipment manuals for specific instructions. Perform most maintenance items annually even if hour levels aren't reached. You may choose to do many yourself, But. its awise to have a qualified mechanic check on the engine, generator, and other key equipment. Volvo Penta & Northern Lights engines are assumed. Check the respective manuals if your brands differ.

9.10 BOAT LIFT AND BUNK OFFSETS

A boat bunk (the shaded gray area in the drawing below) is a support shaped in three dimensions to fit and support the boat. The length and cross section dimensions to make boat bunks are below.

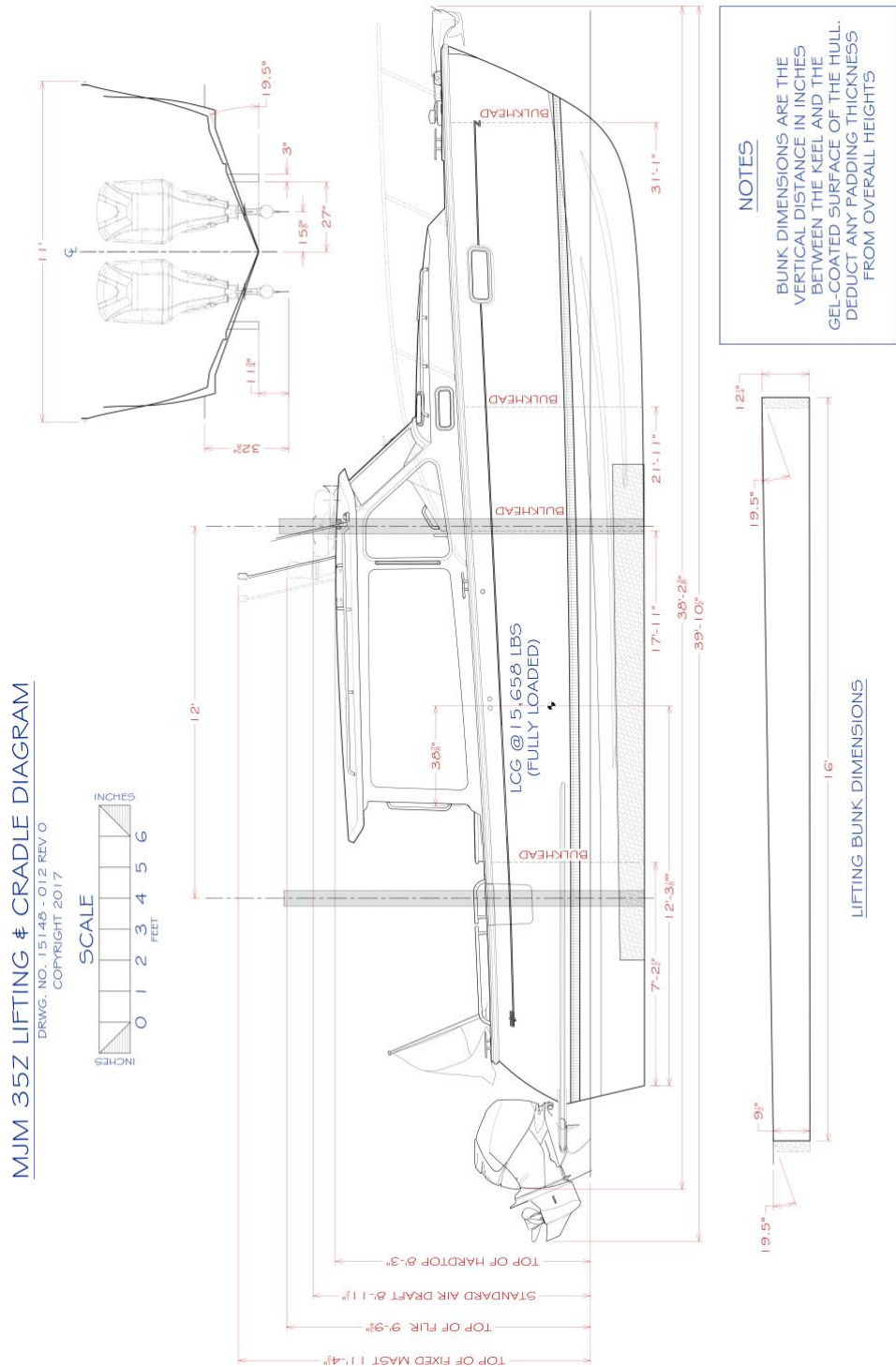

9.11 SYSTEMS LOCATION PLAN

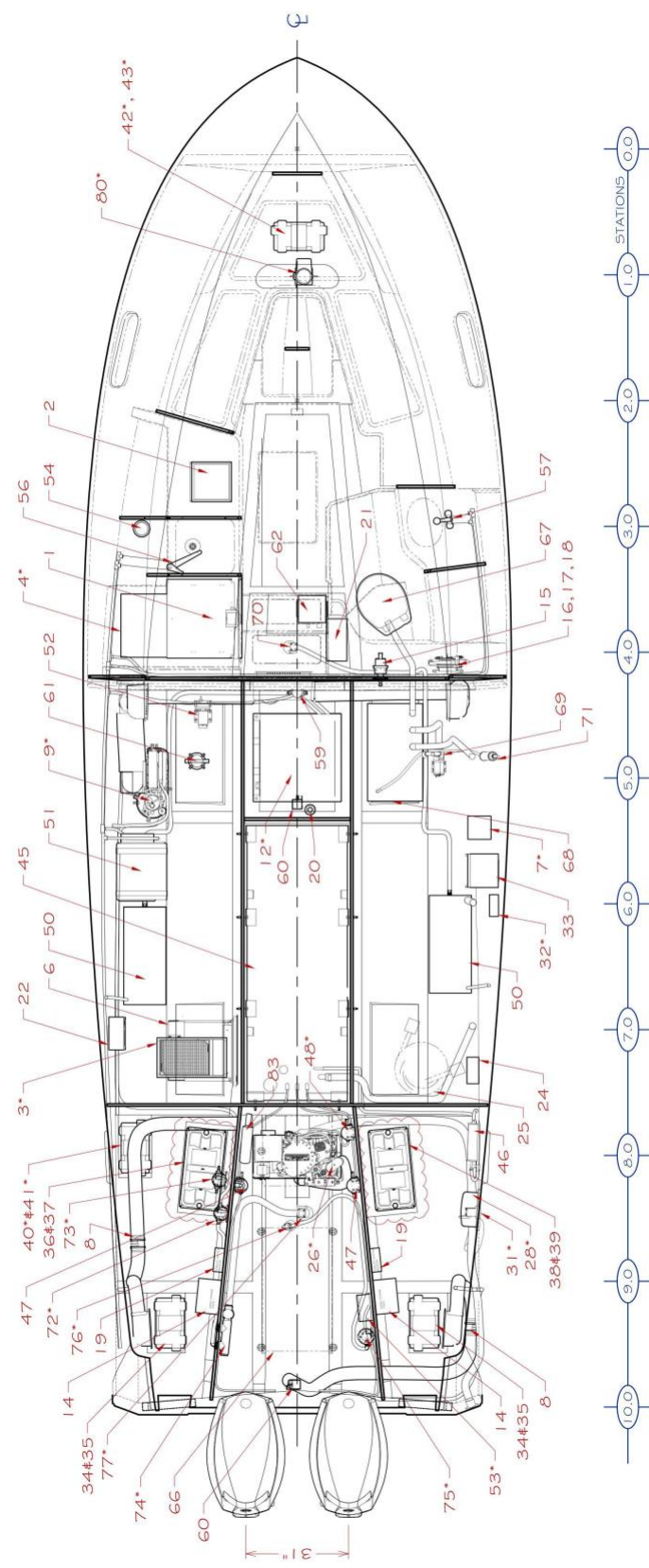

9.12 SYSTEMS KEY

The System Location Plan (above) and the System Key are the baseline configuration for the MJM35. There are modifications due to continuous improvement and individual customization. Your boat will have some differences.

REF	QTY	DESCRIPTION	MAKE	MODEL
01	1	Refrigerator - Cabin	Vitrifigo	DW70 RXP4-EF-2
02	1	Cooktop - Ceramic, 1 Burner	Kenyon	B40571 PUPS
03*	1	Electric Grill (Service Bar)	Kenyon	B7005B
4*	1	Microwave	Frigidaire	FFCM0934LS
5*	1	Refrigerator-Bar (Not Stowed)	Vitrifigo	CG210D4-F
6	1	IceMaker - Bar	Vitrifigo	IMTKN1-F
7*	1	Central Vac	Dirt Devil	CV1500
8	2	Air Extraction Fan - 4" Axial	Attwood	10182-4000 #1749-4
9*	1	AC - Air Handler	Manne Air	DTU1G
10	1	Black Water - Overboard Discharge Vented Loop	Groco	HVL-1000
11	2	Interceptors	Zipwake	-4505
12*	1	Gyro	SeaKeeper	SK3
13	6	Hold Downs - Standard and Optional Grating	Sea-Dog	221670
14	2	Steering - Power Pack	Mercury	892440
15	1	Helix - Electronic	Mercury	Lord
16	1	Steering - Internal Measurement Unit	Mercury	8m00G3320
17	1	Steering - 010 Helm Board	Mercury	8m210027B
18	1	Steering - Gateway	Mercury	8m00S2772
19	2	Steering - Thrust Vector Module	Mercury	8m300269G
20	1	Depth Transducer	Raymarine	A22112
21	1	AC/DC Electrical Panel	Blue Seas	DC-3609726 / AC-3609296
22	1	Charger - House	Victron	Centaur 12/100
23	-	- RESERVED -	- RESERVED -	- RESERVED -
24	1	Galvanic Isolator, 30A	Promanner	ProSafeF530 22034
25	1	Shore Power Cord - 30A, 50ft	Hubbell	HBLG1CM04WLED
26*	1	Genset - 3.5kW, Gas	Westerbeke	3.5kW
27*	1	Genset - Muffler	Westerbeke	Quiet Hush
28*	1	Genset - Water Separator, 2"	Centek	1020200P
29*	1	Genset - Rawwater Siphon Break	-	INC. WITH WESTERBEKE
30*	1	Genset - Dry Exhaust Outlet, 2"	Manne Hardware	9405930
31*	1	Genset - Wet Exhaust Silencer, 1 1/2"	Forespar	931156
32*	1	Solar Charger Controller	Victron	MPT75/15
33	1	Inverter - 3000W	Victron	Phoenix 12/3000
34	2	Battery - Engine	West Marine	Group 31 AGM #1502026
35	2	Battery Box - Engine	West Marine	Group 2731 #2233604
36	1	Battery - House, Port	West Marine	Group 4D AGM #1502026
37	1	Battery Box - House, Starboard	West Marine	Group 4D #14201834
38	1	Battery - House, 5thbd	West Marine	Group 4D AGM #1502026
39	1	Battery Box - House, 6thbd	West Marine	Group 4D #14201834
40*	1	Battery - Genset	West Marine	Group 27 AGM #1502026
41*	1	Battery Box - Genset	West Marine	Group 2731 #2233604
42*	1	Battery - Thruster	West Marine	Group 31 AGM #1502026
43*	1	Battery Box - Thruster	West Marine	Group 2731 #2233604
44	-	- RESERVED -	- RESERVED -	- RESERVED -
45	1	Tank - Fuel, 250 Gal, 3/16" ALU	Florida Marine Tanks	FMT-253-BDW
46	1	Fuel Vent Carbon Filter	Attwood	99CC085-1
47	2	Filter - Engine Fuel	Mercury	8M0095669
48*	1	Filter - Genset Fuel	Racor	320R-RAC-02
49	-	- RESERVED -	- RESERVED -	- RESERVED -
50	2	Tank - Fresh Water, 25 gal	Moeller	WT2502
51	1	Water Heater - 8 gal	Isotherm	Basic 30
52	1	Pump - Fresh Water	Jabco	42755-0092
53*	1	Outboard Flushing System	Reverso	OFB-2-12
54	1	Freshwater Purification System	General Ecology	Seagull IV X-1F
55	-	- RESERVED -	- RESERVED -	- RESERVED -
56	1	Faucet - Galley	Scandvik	10480
57	1	Faucet - Head, Pull-Out	Scandvik	46010
58	1	Shower - Cockpit	Scandvik	12144
59	1	Strainer - 90 DEG, 1/2"	Jabco	46400-0012
60	2	Pump - Bilge Auto - 1"	Rule	27DA-6,120GR, 122R
61	1	Pump - Bilge, Manual	Bosworth	GH-M5000 (MSV)
62	1	Pump - Sump A/C	Aspen	Max 250W 1535-65; 83912
63	2	Thru-Hull - Bilge Water, Auto 1-1/2"	Manne Town	(BUILDER SPEC)
64	1	Thru-Hull - Bilge Water, Manual 1-1/2"	Manne Town	(BUILDER SPEC)
65	1	Thru-Hull - Sump, 3/4"	Manne Town	(BUILDER SPEC)
66	1	Grating - Machinery Space	McMaster Carr	66035T3 4x4'
67	1	Toilet	Dometic	Master Flush 8112
68	1	Tank - Black Water, 22 gal	Moeller	WT2502
69	1	Pump - Black Water Discharge	Jabco	18590-2092
70	1	Thru-Hull/Seacock - Black Water Discharge, 1"	Forespar	931144
71	1	Filter - Black Water Tank Vent	Sealand	Samgard 5/8"
72*	1	Pump - Seawater - A/C, 3.3 GPM	ShurFlo	2088-594-154

73*	1	Pump - Seawater - Gyro, 5.2 GPM	Johnson	10-13252-107-BW
74*	1	Seawater Strainer - Gyro & A/C, 1" #20 MESH	Groco	ARG-1000-5
75*	1	Seawater Strainer - Genset, 1/2"	Sherwood	15935
76*	1	Thru-Hull/Seacock - Genset, 1"	Forespar	931144V
77*	1	Thru-Hull/Seacock - Gyro & A/C, 1"	Forespar	931144V
78*	1	Baitwell	Kodiak	PF-32
79	-	- RESERVED -	- RESERVED -	- RESERVED -
80*	1	Bow Thruster	Side Power	SEGO
81	2	Wiper/Washer Assembly	Intra	Motor - RC53324 Arm - RC536324 Blade - RC520322
82	2	Fire Extinguisher - Portable	Kalke	Manner 10
83	1	Fire Suppression System	Sea Fire	FG75A

9.13 WIRING DIAGRAMS

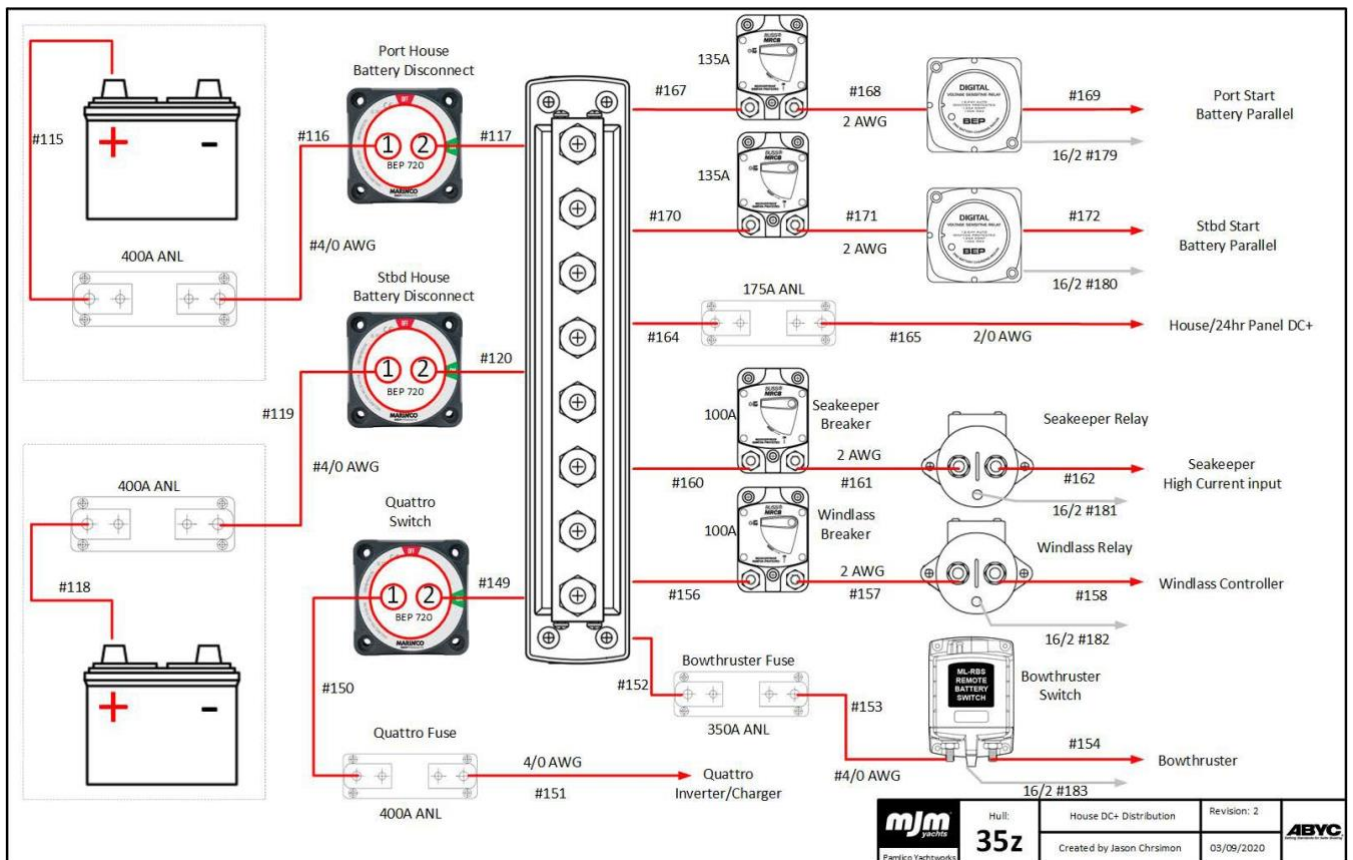
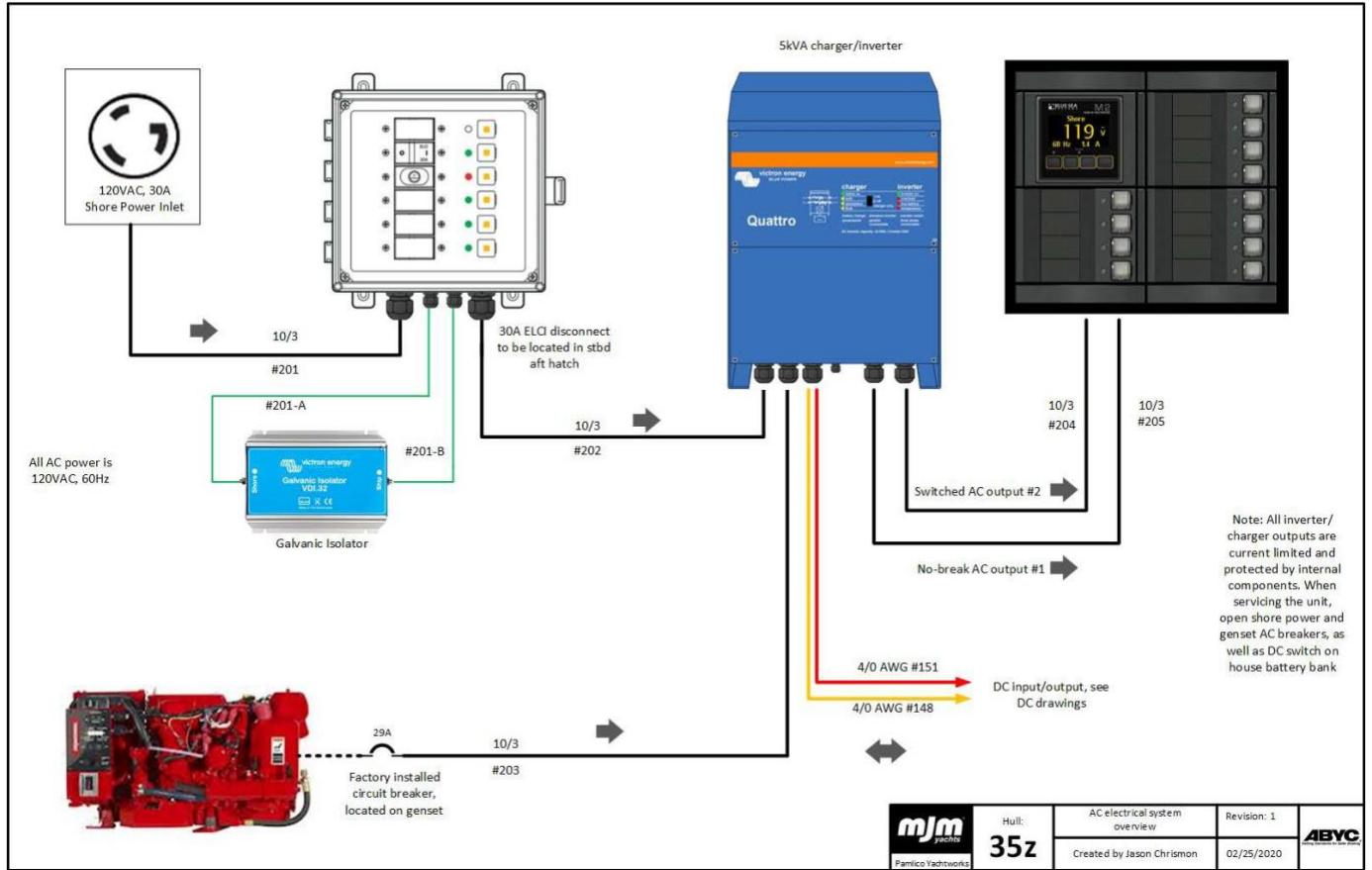

9.14 FUSE LOCATIONS & SPECIFICATIONS

Most fuse locations are at the 24hr and electronics fuse block behind the helm. See diagram located on the fuse block cover for a description.

Fuses located at both port and starboard battery switches: Voltage sense (ATC), engine CPU (ATC), and power steering pump (MRBF).

Fuses located at the generator switch: Seafire controller, port blower, starboard blower (all are ATC)

In addition, the Zipwake controller has a fuse located inside the controller adjacent to the starboard starting battery

ANL Fuses

#	Description	Size	Type	Location
1	Horn Fuse	40	ANL	Next to HORN COMPRESSOR port settee hatch
2	24H Fuse Block	100	ANL	Next to HOUSE BATTERY 1 starboard settee hatch
3	Main Panel Fuse	100	ANL	Wall above FUEL TANK starboard settee hatch
4	Windlass Fuse	130	ANL	Wall above FUEL TANK starboard settee hatch
5	Start Battery 1 Fuse	200	ANL	Above START BATTERY 1 starboard settee hatch
6	House Battery 1 Fuse	200	ANL	Next to HOUSE BATTERY 1 starboard settee hatch
7	Start Battery 2 Fuse	200	ANL	Above START BATTERY 2 starboard settee hatch
8	House Battery 2 Fuse	200	ANL	Next to HOUSE BATTERY 2 port settee hatch
9	House Bank Fuse	250	ANL	Next to HOUSE BATTERY 2 port settee hatch
10	House Parallel Fuse Stbd.	250	ANL	Next to HOUSE BATTERY 1 starboard settee hatch
11	House Parallel Fuse Port	250	ANL	Next to HOUSE BATTERY 2 port settee hatch
12	Inverter Charger Fuse	400	ANL	Wall above FUEL TANK starboard settee hatch
13	Inverter Fuse	400	ANL	Next to HOUSE BATTERY 1 starboard settee hatch
14	Amplifier	100	ANL	Wall above FUEL TANK starboard settee hatch

AGC fuses are a glass, ATC fuses are plastic, ANL fuses for main circuit protection can take a brief overload.

Pamlico Yachtworks Limited Warranty

Manufacturer's Sole and Limited Warranty for Pleasurecraft

A. General. This document sets forth the sole and limited warranty ("The Manufacturer") is giving you in connection with the "Vessel" which you are acquiring. It is the only warranty being given by the Manufacturer and should be reviewed carefully together with manuals and other instructional material provided by the Manufacturer before you take delivery of the Vessel.

B. Basic Warranty. The Manufacturer warrants that the Vessel (except for Excluded items described below and when Properly Used, will be free of defects in material and workmanship for a period of twelve (12) months from delivery of the Vessel to you by an Authorized Dealer. If you sell the Vessel during this period, your buyer may receive the benefit of the balance of the warranty by agreeing to be bound by its terms.

c. Extended Warranty for Structure. In addition to the foregoing warranty, the Manufacturer warrants that the stringer systems, structural bulkheads and composite laminates of the Vessel (except for Excluded items) and when the Vessel is Properly *Used and Maintained, will be free of defects in material and workmanship for a period of five (5) years from delivery date by an Authorized Dealer. This warranty may be transferred to your buyer in the same manner as the Basic Warranty. *Improper over-the-road trucking of the vessel can cause local damage to the centerline of the boat requiring a localized FRP repair. Use authorized MJM trucking companies moving your boat

managers for proper trucking information PRIOR to engaging with another trucking provider for boat transport.

D. Extended Warranty Against Osmotic Blistering. In addition to the foregoing warranties, the Manufacturer warrants that any gelcoat surfaces of the Vessel below the waterline won't blister when the Vessel is Properly Used for a period often (10) years from delivery date by an Authorized Dealer. This warranty may be transferred to your buyer on the same manner as the Basic Warranty.

E. Dealers. The name and address of Authorized Dealers is available from the Manufacturer. The Manufacturer doesn't authorize the Dealer, or any other person, to assume for the Manufacturer any liability in connection herewith or any liability or expense incurred in the repairing of its products other than those expressly authorized by the Manufacturer in writing.

F. Excluded Items. The Manufacturer gives no warranty as to:

- a. Paints, varnishes, gelcoats (except where included in paragraph D above) exterior wood, vinyls, fabrics, glass, chrome plating or anodized or other finishes or surface coatings because of the varying quality of these items manufactured by others and the effect resulting from different climactic and use conditions
- b. Engines, mechanical equipment, pumps, batteries, heating, plumbing, refrigeration, electronic components, masts, or other components manufactured by other than the Manufacturer, or the cost of removal or re-installment of the part and disassembly, or reassembly of the unit of which it is a component.
- c. All items not installed by the Manufacturer or altered after their installation, and items installed or altered by Authorized Dealers.
- d. Other than upon first being delivered, leaks in or around hatches, companionways, deck hardware or other leaks which are above the waterline.
- e. Damage to the Vessel (including, but not limited to, wet core) caused by leakage around decks, hardware or other accessories attached to, or incorporated into, the Vessel.
- f. Speed, fuel consumption or other performance characteristics, because they are estimated and not guaranteed.

G. Proper Use. The warranties contained herein are expressly conditioned upon your Proper Use of the Vessel. This means that you must use the Vessel solely as a pleasure craft (no commercial use) and operate it as directed in and after reviewing the manuals provided by the original equipment manufacturer and the Manufacturer and perform maintenance to the Vessel as recommended in the manuals and as required by periodic inspections by an Authorized Dealer or Service Center.

H. Warranty Claims. To make a claim under this warranty you must do the following a. Report the defect to the Manufacturer or Authorized Dealer within 48 hours after discovery, and when possible prior to incurring any expense, identifying the Vessel and submitting photographs (email digital preferred).

b. Make the Vessel available for inspection by the Manufacturer or Authorized Dealer when requested.

c. Make the vessel available for repairs, if required, by the Manufacturer or Authorized Dealer.

d. Major components, such as engines, generators, air-conditioners, electronics, and appliances, for example, are warranted by the manufacturer of the component. They have authorized service dealers in most major boating markets. The Manufacturer or Dealer will identify such service dealers upon request.

I. Repair or Replacement. The manufacturer shall perform its obligations under this warranty by, at its option, repairing or replacing (at Manufacturer's expense) the defective part or component. Parts or components replaced will become the property of the Manufacturer. The replacement of parts or components won't extend the warranty but the replacement parts and components will be covered for the balance of the warranty period. You shall be responsible for returning the Vessel to Manufacturer at its plant or at a marina or to such other repair facility that the Manufacturer shall designate, at your sole expense.

J. Specification Changes. The manufacturer reserves the right to make changes in design, equipment, layout or construction without notice or being obligated to incorporate such changes in previous products.

K. Registration Cards. The Manufacturer recommends that you immediately fill out and return the Warranty Registration Card for the Vessel. Cards should be sent to:

Pamlico Yachtworks, 230 Clarks
Neck Road, Washington NC
27889 ATTN: Customer Service

L. The information contained on this card will enable the Manufacturer to more quickly process any warranty claims and to comply with the Federal

Boating Safety Act. Should you sell the Vessel, the Manufacturer recommends that your buyer also fill out a Warranty Registration Card.

M. Exclusion of Implied Warranties. The foregoing warranty is intended to be in lieu of all other warranties, express or implied. In part, due to the hazardous, life-threatening environment, capable of overwhelming vessels of any size, that the Vessel will operate in, THE MANUFACTURER OR ITS DEALER DISCLAIMS ALL IMPLIED WARRANTIES INCLUDING WARRANTIES OF MERCHANTABILITY AND FITNESS FOR A PARTICULAR USE. In some jurisdictions, the Manufacturer is prohibited from excluding or limiting implied warranties. In those jurisdictions, the Manufacturer expressly limits any implied warranties to the greatest extent and to the shortest duration allowed by law.

N. Limitation of Damages. THE MANUFACTURER OR ITS DEALER DISCLAIMS ANY LIABILITY TO YOU FOR INCIDENTAL, CONSEQUENTIAL OR INDIRECT DAMAGES TO YOU, including loss of use, loss of revenue, travel expenses, transportation charges, food or lodging charges or loss of personal property. In some jurisdictions, the Manufacturer is prohibited from excluding or limiting implied warranties. In those jurisdictions, the Manufacturer expressly limits any implied warranties to the greatest extent and to the shortest duration allowed by law.

o. Whole Agreement. This warranty is the sole warranty given to you by the Manufacturer. Authorized Dealers aren't authorized to make changes to this warranty. Any questions about the warranty should be directed to the Manufacturer. If you do bring a claim against the Manufacturer that is related to the Vessel, you must bring it in the Courts for the State of Massachusetts.

Limited Warranty Registration Card

Within 30 days after delivery or transfer to new owner, this form must be sent to:

Pamlico Yachtworks
230 Clarks Neck Road
Washington NC 27889
ATTN: Customer Service

_____ / / _____
MJM Model Hull # (HIN) US-EOU Authorized Dealer Date Purchased

Owner(s):

_____ / _____
First name Last name

_____ / _____
First name Last name

_____ / _____ / _____
Address City State Zip

_____ / _____ / _____
Primary phone Mobile phone email

_____ / _____
Boat Name Hailing Port

I have read and agree to the conditions outlined in the Limited Warranty, which was attached hereto:

_____ / _____
Owner(s) Signature(s) Date

Warranty Claim Application Form

Pamlico Yachtworks
230 Clarks Neck Road
Washington NC 27889

Date:

Boat name

Dealer/service

Address

Address continued

Phone # & email

Fax

Contact person

Hull #

Boat Owner

Address

Address Continued

Phone Number & e-mail

Boat Location

Delivery Date

Description of Defect (please attach photos)

Description of Corrective Action (please attach invoices)

_____	_____
_____	Labor hrs
_____	_____
_____	Labor rate
_____	_____
_____	Labor cost
_____	_____
_____	Material cost
_____	_____
_____	Total Cost

All claims require prior approval from Customer Service at Pamlico Yachtworks.

_____ Date Approved _____ Amount Approved _____ Approved by

